

**2025/26**

# **SNACK BAR EQUIPMENT**

**Macchinari per la piccola ristorazione**



# Guida alla Lettura

READING GUIDE  
GUIDE DE LECTURE  
LESEHILFE  
GUÍA DE LECTURA  
РУКОВОДСТВО ПО ЧТЕНИЮ

## IT

Easyline by Fimar è la linea dedicata alle esigenze della piccola ristorazione e bar di tipo professionale, prodotta da fornitori selezionati a prezzi concorrenziali.

Easyline nasce nel 2013, come linea di prodotti di importazione a prezzi straordinariamente contenuti crescendo ogni anno in qualità e in ampliamento della gamma di articoli.

Per offrire alla nostra clientela un'ampia scelta di prodotti, nel catalogo troverete alcuni brand di fama internazionale come i Forni a Microonde di Samsung® o Panasonic® e le famose Impastatrici Kitchenaid®.

## EN

Easyline by Fimar is the professional line dedicated to the needs of small restaurants and bars, produced by selected suppliers at competitive prices.

Easyline was born in 2013, as a line of imported products at extraordinarily low prices, growing every year in quality and extension of the range of articles.

In order to offer our customers a wide choice of products, in the catalogue you will find some internationally renowned brands such as Microwave Ovens from Samsung® or Panasonic® and the famous Kitchenaid® mixers.

## FR

Easyline by Fimar est la ligne professionnelle dédiée aux besoins des petits restaurants et bars, produite par des fournisseurs sélectionnés à des prix compétitifs.

Easyline est née en 2013, comme une ligne de produits importés à des prix extraordinairement bas, augmentant chaque année en qualité et en expansion de la gamme d'articles. Afin d'offrir à nos clients un large choix de produits, vous trouverez dans le catalogue certaines marques de renommée internationale telles que les fours à micro-ondes de Samsung® ou Panasonic® et les célèbres mélangeurs Kitchenaid®.



Cerca il bollino novità e scopri le tutte!

Look for the new sticker and discover them all!

Cherchez la vignette de la nouveauté et découvrez-les tous!

Achten sie auf den neuheitsaufkleber und entdecken sie sie alle!

¡Busque la etiqueta de novedad y descúbralos todos!

Найдите наклейку с новинкой и откройте для себя их все!



DE

Easyline by Fimar ist die professionelle Linie, die auf die Bedürfnisse kleiner Restaurants und Bars ausgerichtet ist und von ausgewählten Lieferanten zu wettbewerbsfähigen Preisen hergestellt wird.

Easyline wurde im Jahr 2013 als eine Linie von importierten Produkten zu außergewöhnlich niedrigen Preisen geboren, die jedes Jahr an Qualität und Erweiterung der Artikelpalette zunimmt. Um unseren Kunden eine große Auswahl an Produkten zu bieten, finden Sie im Katalog einige international bekannte Marken wie die Mikrowellenherde von Samsung® oder Panasonic® und die berühmten Kitchenaid®-Mixer.

ES

Easyline by Fimar es la línea profesional dedicada a las necesidades de pequeños restaurantes y bares, producida por proveedores seleccionados a precios competitivos.

Easyline nació en 2013, como una línea de productos importados a precios extraordinariamente bajos, creciendo cada año en calidad y ampliación de la gama de artículos. Con el fin de ofrecer a nuestros clientes una amplia gama de productos, en el catálogo encontrará algunas marcas de renombre internacional como los Hornos Microondas de Samsung® o Panasonic® y las famosas batidoras Kitchenaid®.



















RU















Easyline by Fimar - это профессиональная линия, посвященная потребностям небольших ресторанов и баров, производимая избранными поставщиками по конкурентоспособным ценам.

Easyline родилась в 2013 году как линия импортных продуктов по необычайно низким ценам, с каждым годом повышая качество и расширяя ассортимент. Чтобы предложить нашим покупателям широкий выбор продукции, в каталоге представлены такие всемирно известные бренды, как микроволновые печи Samsung® или Panasonic® и знаменитые миксеры Kitchenaid®.

# Icone

ICONS  
ICÔNES  
SYMBOLE  
ICONOS  
ИКОНКИ

	IT	EN	FR	DE	ES	RU
	INFORMAZIONI	INFORMATION	INFORMATION	INFO	INFORMACIÓN	ИНФОРМАЦИЯ
	POTENZA	POWER	PUISSANCE	LEISTUNG	POTENCIA	МОЩНОСТЬ
	ALIMENTAZIONE TRIFASE	THREE-PHASE POWER SUPPLY	ALIMENTATION TRIPHASÉE	DREIPHASIGE STROMVERSORGUNG	ALIMENTACIÓN TRIFÁSICA	ТРЕХФАЗНЫЙ ИСТОЧНИК ПИТАНИЯ
	ALIMENTAZIONE MONOFASE	SINGLE-PHASE POWER SUPPLY	ALIMENTATION MONOPHASÉE	EINPHASIGE STROMVERSORGUNG	ALIMENTACIÓN MONOFÁSICA	ОДНОФАЗНЫЙ ИСТОЧНИК ПИТАНИЯ
	DIMENSIONI MACCHINA	MACHINE DIMENSIONS	DIMENSIONS DES MACHINES	MASCHINE NABMESSUNGEN	MEDIDAS MÁQUINA	РАЗМЕРЫ СТАНКА
	INFO SPEDIZIONI	DELIVERY INFO	INFORMATIONS SUR LA LIVRAISON	VERSANDINFO	INFORMACIÓN SOBRE ENVÍO	ИНФОРМАЦИЯ ИНФОРМАЦИЯ ШИППИНГА
	PESO NETTO	NET WEIGHT	POIDS NET	NETTOGEWICHT	PESO NETO	ВЕС НЕТТО
	PESO LORDO	GROSS WEIGHT	POIDS BRUT	BRUTTOGEWICHT	PESO BRUTO	ВЕС БРУТТО
	DIMENSIONI DI IMBALLO	PACKAGING DIMENSIONS	DIMENSIONS DES EMBALLAGES	VERPACKUNGSMASSE	MEDIDAS DEL EMBALAJE	РАЗМЕРЫ УПАКОВКИ
	VOLUME DI IMBALLO	PACKING VOLUME	VOLUME D'EMBALLAGE	VERPACKUNGSUMFANG	VOLUMEN DEL EMBALAJE	ОБЪЕМ УПАКОВКИ
	PREZZO	PRICE	PRIX	PREIS	PRECIO	ПРИСЕ
	CE	CE	CE	CE	CE	CE
	BARRA SALDANTE	SEALING BAR	BARRE DE SOUDURE	SCHWEISSSTAB	BARRA TERMOSELLADO	СВАРОЧНАЯ ПЛАНКА
	POMPA VUOTO/ VACUUM PUMP	VACUUM PUMP	POMPE A VIDER	VAKUUM PUMPE	BOMBA VACÍO	ВАКУУМНЫЙ НАСОС
	VUOTO MAX OTTENIBILE/ MAX ACHIEVABLE VACUUM	MAX. VAKUUM ACHIEVABLE	VIDE MAX POSSIBLE	MAX ERREICHBARES VAKUUM	MÁX. VACÍO POSIBLE	МАКСИМАЛЬНО ВОЗМОЖНАЯ ВАКУУМНЫЙ
	DIMENSIONI DEL PIANO DI LAVORO	DIMENSIONS OF THE WORKTOP	DIMENSIONS DU PLAN DE TRAVAIL	ABMESSUNGEN DER ARBEITSPLATTE	MEDIDAS DEL PLAN DE TRABAJO	РАЗМЕРЫ СТОЛЕШНИЦЫ
	POTENZA RISCALDAMENTO	HEATING POWER	PUISSANCE DE CHAUFFAGE	HEIZLEISTUNG	POTENCIA CALORÍFICA	МОЩНОСТЬ НАГРЕВА
	TEMPERATURA DI LAVORO	WORKING TEMPERATURE	TEMPÉRATURE DE FONCTIONNEMENT	BETRIEBSTEMPERATUR	TEMPERATURA DE TRABAJO	РАБОЧАЯ ТЕМПЕРАТУРА

	IT	EN	FR	DE	ES	RU
	VELOCITÀ	SPEED	VITESSE	GESCHWINDIGKEIT	VELOCIDAD	СКОРОСТЬ
	CAPACITÀ DEL BICCHIERE	GLASS CAPACITY	CAPACITÉ DU VERRE	BECHERKAPAZITÄT	CAPACIDAD VASO	ЁМКОСТЬ СТЕКЛА
	TIMER	TIMER	MINUTERIE	SCHALTUHR	TEMPORIZADOR	ТАЙМЕР
	DIMENSIONI DEL PIANO DI COTTURA	DIMENSIONS OF THE COOKING SURFACE	DIMENSIONS DE LA TABLE DE CUISSON	ABMESSUNGEN DER KOCHPLATTE	MEDIDAS DE LA PLACA DE COCCIÓN	РАЗМЕРЫ ВАРОЧНОЙ ПАНЕЛИ
	PRODUZIONE ORARIA	HOURLY PRODUCTION	PRODUCTION HORAIRE	STUNDENPRODUKTION	PRODUCCIÓN HORARIA	ПОЧАСОВОЕ ПРОИЗВОДСТВО
	CAPACITÀ NOMINALE	NOMINAL CAPACITY	CAPACITÉ NOMINALE	NENNKAPAZITÄT	CAPACIDAD NOMINAL	НОМИНАЛЬНАЯ МОЩНОСТЬ
	CAPACITÀ OLIO	OIL CAPACITY	CAPACITÉ D'HUILE	ÖLKAPAZITÄT	CAPACIDAD ACEITE	МАСЛО КАПАБИЛЬТИЯ
	CAPACITÀ DEL CESTO DI COTTURA	CAPACITY OF THE COOKING BASKET	CAPACITÉ DE LA CUVE DE CUISSON	KAPAZITÄT DES KOCHKORBES	CAPACIDAD CESTA PARA COCCIÓN	ГЛАВНАЯ ИЛИ ВЫДЕЛЕННАЯ ПОВЕРХНОСТЬ ПЛИТЫ
	DIMENSIONE DELLA LAMA	BLADE SIZE	TAILLE DE LA LAME	KLINGENGRÖSSE	MEDIDA DE LA CUCHILLA	НОЖА
	TAGLIO UTILE	USEFUL CUT	COUPE UTILE	NÜTZLICHER SCHNITT	ÚTIL DE CORTE	ПОЛЕЗНАЯ ДЛИНА РЕЗКИ
	LAME BLADES ЛЕЗВИЙ	BLADES	LAMES	KLINGEN	CUCHILLAS	НОЖИ
	CAVALLETTO	STAND	SUPPORT	GESTELL	CABALLETE	МОЛЬБЕРТ
	CAPACITÀ / DIMENSIONI DELLA CAMERA DI COTTURA	CAPACITY / DIMENSIONS OF THE BAKING CHAMBER	CAPACITÉ / DIMENSIONS DE LA CHAMBRE DE CUISSON	BACKKAMMER KAPAZITÄT / ABMESSUNGEN	CAPACIDAD / DIMENSIONES DE LA CAMARA DE COCCIÓN	КАПАБИЛЬТИЯ / ВРЕМЕНИИ КАМЕРА ВЫПЕЧКИ
	DIMENSIONE RULLI	ROLLER DIMENSIONS	LONGUEUR DES ROULEAUX	ROLLENLÄNGE	LARGO RODILLOS	РАЗМЕР РОЛИКА
	ALTEZZA UTILE PER LA COTTURA	USEFUL COOKING HEIGHT	HAUTEUR UTILE POUR LA CUISSON	NUTZHÖHE ZUM KOCHEN	ALTURA ÚTIL PARA LA COCCIÓN	ПОЛЕЗНАЯ ВЫСОТА ДЛЯ ПРИГОТОВЛЕНИЯ ПИЦЦЫ











# INDICE

INDEX  
TABLE DES MATIÈRES  
INHALTSVERZEICHNIS  
ÍNDICE  
СОДЕРЖАНИЕ





IT	EN	FR	DE	ES	RU	
CONDIZIONI GENERALI DI VENDITA	GENERAL SALES CONDITIONS	CONDITIONS GÉNÉRALES DE VENTE	ALLGEMEINE VERKAUFSBEDINGUNGEN	CONDICIONES GENERALES DE VENTA	ОБЩИЕ УСЛОВИЯ ПРОДАЖИ	10
FRULLATORI	MIXERS	BLENDERS	MIXERS	LICUADORA	БЛЕНДЕРЫ	12
FRULLATORI FRAPPÈ	MILKSHAKER	BLENDERS À FRAPPÉS	MILKSHAKERS	LICUADORAS FRAPPÉ	БЛЕНДЕРЫ ДЛЯ ПРИГОТОВЛЕНИЯ ФРАППЕ	14
FRULLATORI CON FUNZIONE COTTURA	MIXERS WITH COOKING FUNCTION	MIXEUR AVEC FONCTION CUISSON	MIXERS MIT KOCHFUNKTION	LICUADORA CON FUNCIÓN DE COCCIÓN	МЕШАЛКА С ФУНКЦИЕЙ ПРИГОТОВЛЕНИЯ ПИЩИ	16
FRULLATORI CON INSONORIZZATORE	MIXERS WITH SOUND-PROOFER	MÉLANGEURS AVEC INSONORISATION	MIXERS MIT SCHALLSCHUTZ	LICUADORA CON INSONORIZADOR	СМЕСИТЕЛИ СО ЗВУКОИЗОЛЯЦИЕЙ	18
ESTRATTORE DI SUCCHI	SLOW JUICER	EXTRACTEUR DE JUS	SAFTPRESSE	EXTRACTOR DE ZUMO	СЛОВ ДЖУЙСЕР	20
CENTRIFUGHE	CENTRIFUGES	CENTRIFUGEUSES	ZENTRIFUGEN	LICUADORA CENTRÍFUGA	ЦЕНТРИФУГИ	22
SPREMIAGRUMI	CITRUS JUICER	PRESSE-AGRUMES	ZITRUSPRESSE	EXPRIMIDORES	СОКОВЫЖИМАЛКИ ДЛЯ ЦИТРУСОВЫХ	24
IMPASTATRICE A BRACCIA TUFFANTI	MIXER WITH PLUNGING ARMS	MÉLANGEUR À BRAS PLONGEANTS	MISCHER MIT TAUCHARMEN	AMASADORA CON BRAZOS SUMERGIBLES	МИКСЕР С ПОГРУЖНЫМИ РЫЧАГАМИ	26
IMPASTATRICI PLANETARIE	PLANETARY MIXER	MÉLANGEUR PLANÉTAIRE	PLANETENMISCHER	AMASADORA PLANETARIA	ПЛАНЕТАРНЫЙ ТЕСТОМЕС	28
IMPASTATRICE PLANETARIA KITCHENAID	PLANETARY MIXER	MÉLANGEUR PLANÉTAIRE	PLANETENMISCHER	AMASADORA PLANETARIA	ПЛАНЕТАРНЫЙ ТЕСТОМЕС	36
PIASTRE DI COTTURA IN GHISA	CAST IRON COOKING GRILLS	PLAQUES DE CUISSON EN FONTE	KOCHPLATTEN AUS GUSSEISEN	PLACA DE COCINA DE FUNDICIÓN	ЧУГУННЫЕ ВАРОЧНЫЕ ПАНЕЛИ	40
PIASTRE AD INDUZIONE	INDUCTION PLATES	PLAQUES A INDUCTION	INDUKTIONSPLETTEN	PLACAS DE INDUCCIÓN	ИНДУКЦИОННЫЕ ПЛИТЫ	42
TOSTAPANE CONTINUO	TOASTER	GRILLE-PAIN CONTINU	TOASTER IM DAUERZYKLUS	TOSTADORA DE PAN CONTINUA	ТОСТЕР НЕПРЕРЫВНОГО ДЕЙСТВИЯ ДЛЯ ПРИГОТОВЛЕНИЯ ГРЕНОК	52
SALAMANDRE	SALAMANDERS	SALAMANDER	SALAMANDER	SALAMANDRAS	ГРИЛЬ САЛАМАНДР	54
FRY TOP ELETTRICI	ELECTRIC FRY-TOPS	FRY-TOP ÉLECTRIQUE	ELEKTRISCHE FRY TOP	FRY TOP ELÉCTRICOS	ЭЛЕКТРИЧЕСКИЕ ЖАРОЧНЫЕ ПОВЕРХНОСТИ	56
WAFFLE MACHINE	WAFFLE MACHINE	APPAREIL À GAUFRES	WAFFELMASCHINEN	GOFRERA	МАШИНА ДЛЯ ВЫПЕКАНИЯ ВАФЕЛЬ	58
FORNI PIZZA ELETTRICI	ELECTRIC PIZZA OVENS	FOURS À PIZZA ÉLECTRIQUES	ELEKTRISCHE PIZZAÖFEN	HORNOS ELÉCTRICOS PARA PIZZA	ЭЛЕКТРИЧЕСКИЕ ПЕЧИ ДЛЯ ПИЦЦЫ	60
FORNO COMBINATO SPEED OVEN	COMBI OVEN SPEED OVEN	FOUR COMBINÉ SPEED OVEN	COMBI-OFEN SPEED OVEN	HORNOS DE CONVECCIÓN SPEED OVEN	КОМБИНИРОВАННАЯ ДУХОВКА SPEED OVEN	62
FORNI A CONVEZIONE	CONVECTION OVENS	FOURS À CONVECTION	KONVEKTIONSOFEN	HORNOS DE CONVECCIÓN	КОНВЕКЦИОННЫЕ ПЕЧИ	66
FORNI MICROONDE	MICROWAVES OVENS	FOURS À MICRO-ONDES	MIKROWELLEN	HORNOS MICROONDAS PROFESIONALES	ПРОФЕССИОНАЛЬНЫЕ МИКРОВОЛНОВЫЕ ПЕЧИ	70
FORNI A MICROONDE SAMSUNG	SAMSUNG MICROWAVES OVENS	FOURS À MICRO-ONDES SAMSUNG	SAMSUNG MIKROWELLEN	HORNOS MICROONDAS SAMSUNG	МИКРОВОЛНОВЫЕ ПЕЧИ SAMSUNG	76
FORNI A MICROONDE PANASONIC	PANASONIC MICROWAVES OVENS	FOURS À MICRO-ONDES PANASONIC	PANASONIC MIKROWELLEN	HORNOS MICROONDAS PANASONIC	МИКРОВОЛНОВЫЕ ПЕЧИ PANASONIC	78
FRIGGITRICI	FRYERS	FRITEUSES	FRITEUSEN	FREIDORAS	ФРИТЮРНИЦЫ	80
CUOCI HOT DOG	HOT DOG	HOT DOG	HOT DOG	PERRITO CALIENTE	АППАРАТ ДЛЯ ПРИГОТОВЛЕНИЯ ХОТ-ДОГОВ	84
CUOCI RISO	RICE COOKER	CUISINIÈRE À RIZ	REISKOCHER	COCEDORES DE ARROZ	РИСОВАРКА	88
COTTURA SOUS-VIDE	SOUS-VIDE COOKING	CUISSON SOUS-VIDE	VAKUUM GAREN	COCCIÓN SOUS-VIDE	ВАКУУМНАЯ ВАРКА	90
MACCHINE SOTTOVUOTO A BARRA SALDANTE	BAR VACUUM PACKERS	MACHINES SOUS VIDE À BARRE	VAKUUMVERPACKER MIT SCHWEISSLEISTE	ENVASADORAS AL VACÍO CON BARRA	ВАКУУМНЫЕ УПАКОВОЧНЫЕ МАШИНЫ СО СВАРОЧНОЙ ПЛАНКОЙ	92
MACCHINE SOTTOVUOTO A CAMPANA	CHAMBER VACUUM PACKERS	MACHINES SOUS VIDE À CLOCHE	KAMMER VAKUUMVERPACKER	ENVASADORAS AL VACÍO	КОЛПАКОВЫЕ ВАКУУМНЫЕ УПАКОВОЧНЫЕ МАШИНЫ	94
AFFETTATRICI A GRAVITÀ	GRAVITY SLICERS	TRANCHEUSE À GRAVITÉ	SCHRÄGE AUFSCHNITTMASCHINEN	CORTADORAS POR GRAVEDAD	ГРАВИТАЦИОННЫЕ СЛАЙСЕРЫ	98
TAGLIA POMODORI MANUALI	MANUAL TOMATOES CUTTER	COUPE-TOMATES MANUELS	MANUELLER TOMATENSCHNEIDER	CORTADORA MANUAL DE TOMATES	РУЧНАЯ РЕЗКА ПОМИДОРОВ	100
PRESSAMBURGER MANUALI	MANUAL HAMBURGER PRESS	PRESSE-HAMBURGER MANUELS	MANUELLE HAMBURGER-PRESSE	PRESA DE HAMBURGUESAS MANUAL	ПРЕСС ДЛЯ ГАМБУРГЕРОВ	102
BOLLITORE ELETTRICO	ELECTRIC KETTLE	BOUILLIÈRE ÉLECTRIQUE	WASSERKOCHER	HERVIDOR ELÉCTRICO	ЭЛЕКТРИЧЕСКИЙ ЧАЙНИК	104





# Indice

INDEX  
TABLE DES MATIÈRES  
INHALTSVERZEICHNIS  
ÍNDICE  
СОДЕРЖАНИЕ

CODICE / CODE	
B10K	32
B20K	32
B30K	32
B40K	32
B60I	32
BH10	 32
BH20	 32
BH30	 32
BH40	 32
BH5	30
BH60	 32
BH7	30
BL010	12
BL020BN	12
BL020S	12
BT310T3	48
BT350T2	 46
BT350W	50
BT700D3	 42
CJ900A	22
CVT1	52
D20N	 46

CODICE / CODE	
D350N	 46
DMB	14
DMB20	14
E200A	44
E350C	44
E350D	44
E500A	42
EG548	56
EG5482	56
EG750	56
EG750M	56
EM025FJT	74
EMA34GTQ	74
EMH450S	54
EMH600S	54
EMH800S	54
ESTA3	52
ET350G	48
FD21	68
FD47	68
FD66	68
FT901MD	18

CODICE / CODE	
FY011	86
FY44L	80
FY4L	80
FY88L	80
FY8L	80
FYEP1	 60
FYEP2	 60
FYK04	84
FZ03A	90
H7530	 66
HBS220JS	98
HBS250	98
HBS300	98
HF100	102
HF130	102
HT4	100
HT55	100
K55	<b>KitchenAid</b> 36
K7P	<b>KitchenAid</b> 36
LSG8	 18
M25LZS	70
MC2452	72

CODICE / CODE	
MF914	72
MJ6051AT	 76
MJ6053AT	 76
MJ6091AT	 76
MJ6093AT	 76
NTPROFIT	62
P25EG01	40
P35EG02	40
P50EG03	40
P50EG03M	40
P90DZH	70
PANE1840	<b>Panasonic</b> 78
PANE3240	<b>Panasonic</b> 78
PB009	20
PC700	22
PFD20	48
PFD27N	42
PFD35N	42
PU008	20
RMS20	 26
SACJ4	24
SACJ5	24

CODICE / CODE	
SACJ5A	24
SACJ6	24
SBP350	92
SBP400	92
SBS300P	92
SC8195	88
SCC250	94
SCC300	94
SCC400	94
SCC500	94
SD82C	88
SLB5	28
SLB7	28
SV130	90
T906	104
TM905+Q109	17
WM1	58
WM15	58
WMFY2205	58
WOK	50
XH215	88
YKK02A	84



# Condizioni generali di vendita

IT

**COSTO DELL' IMBALLO:** compreso nel prezzo per le macchine. Per ricambi ed accessori è previsto un contributo di € 8,00; cassa in legno con coperchio per piane refrattarie, il contributo è di € 54,00.

**COSTO FISSO GESTIONE ORDINI:** € 10,00 solo per ordini di importo inferiore a € 100,00.

**ORDINI:** gli ordini devono essere trasmessi esclusivamente in forma scritta; nuovi ordini o eventuali modifiche trasmesse in forma orale non verranno accettate.

**CONDIZIONI DI PAGAMENTO:** Si richiede il pagamento con bonifico bancario per: 1. Prime forniture. - 2. Al superamento del fido. - 3. Invio di ricambi.

**DILAZIONI DI PAGAMENTO:** da definire.

Sulle somme pagate in ritardo rispetto alla scadenza pattuita, saranno addebitati gli interessi di mora al tasso legale. Eventuali note di accredito saranno detratte nella fattura successiva.

**PREZZI:** non sono impegnativi, possono subire variazioni senza obbligo di preavviso, in tal caso saranno confermati all'ordine. Tutti i prezzi sono esclusi di IVA.

**TERMINI DI CONSEGNA:** 1. Per l'Italia, possibile spedizione in 24 ore per macchine disponibili a magazzino. 2. Per macchine da produrre considerare circa 25 giorni salvo imprevisti.

**TRASPORTO:** FRANCO FABBRICA, la merce viaggia a rischio e pericolo del committente, per cui Fimar S.p.a. non è responsabile per eventuali danni subiti dalla merce durante il trasporto. Eventuali contestazioni dovranno essere effettuate all'atto della consegna entro i termini di legge.

**ASSISTENZA TECNICA:** a carico del rivenditore per tutta la durata della garanzia di anni uno. Fimar S.p.a. si impegna a fornire, in garanzia, tutti i componenti di ricambio ritenuti difettosi. Il prezzo di vendita fatturato all'utilizzatore finale comprenderà non solo il prezzo dei prodotti finiti venduti, ma anche la gestione da parte del rivenditore della garanzia a copertura di essi. Fimar S.p.a. non dovrà sostenere alcuna spesa diretta o indiretta sostenuta dal rivenditore per la gestione della garanzia. La garanzia decade sul prodotto danneggiato o compromesso da un uso scorretto o comunque non conforme.

**INSTALLAZIONE:** installazione ed istruzione sull'utilizzo delle macchine e dei suoi accessori sono a carico del rivenditore.

**RIPARAZIONI:** nel caso in cui un preventivo di riparazione non venga accettato verranno addebitati € 25,00 quale concorso spese dei costi di gestione.

**GARANZIA:** 12 mesi.

**RESI:** per eventuali resi autorizzati di merce con imballo integro, sarà trattenuta una quota pari al 15% del valore, con un minimo di € 50.

**ASSICURAZIONE:** tutte le nostre macchine sono coperte da assicurazione (responsabilità civile verso terzi) Escluso U.S.A. e CANADA.

**CATALISTINO:** la presente documentazione annulla tutte le precedenti. I dati tecnici, le illustrazioni e le immagini riportate nella presente, sono puramente indicativi. La Ditta si riserva il diritto di modificare le caratteristiche tecniche ed estetiche o sospendere, in ogni momento, la propria produzione senza obbligo di preavviso.

**IMMAGINI ED ILLUSTRAZIONI:** tutte le immagini realizzate dal produttore sono coperte da copyright. L'utilizzo o la riproduzione delle medesime sono soggette ad autorizzazione da parte della Ditta proprietaria del marchio e detentrica dei diritti di proprietà materiale ed intellettuale. I prezzi o i dati tecnici potranno subire variazioni nel caso di errori tipografici o di cambiamenti in corso d'opera.

**MARCHI E BREVETTI:** è fatto espresso divieto di utilizzare i marchi e/o i brevetti registrati dalla Fimar S.p.a. Si precisa che tutti i macchinari e gli accessori non marchiati CE presentano caratteristiche specifiche che non li rendono idonei alla vendita all'interno dei paesi dell'Unione Europea.

**RICHIESTA DI DOCUMENTAZIONE TECNICA AGGIUNTIVA:** Copia conforme all'originale della Certificazione CE: € 20,00 + spese di spedizione - Copia cartacea del Manuale d'Uso e Manutenzione: € 40,00 + spese di spedizione.

MOD140V05 - FINITO DI STAMPARE NEL SETTEMBRE 2025

EN

**PACKAGING COSTS:** included in the price for equipment. Spare parts and accessories are subject to a surcharge of €8.00. Wooden crate with lid for refractory plates is subject to a surcharge of €54.00.

**FIXED COST OF ORDER MANAGEMENT:** € 10.00 only on orders of less than € 100.00.

**ORDERS:** Orders must be transmitted in written form only; new orders or any changes transmitted in verbal form will not be accepted.

**PAYMENT TERMS:** Payment by bank transfer is required for: 1. First deliveries. - 2. On exceeding the credit limit. - 3. Shipment of spare parts.

**PAYMENT DEFERRALS:** To be defined.

Interest at the legal rate shall be charged on sums paid late with respect to the agreed due date. Any credit notes will be deducted from the next invoice.

**PRICES:** these are not binding, they may vary without prior notice, in which case they will be confirmed on the order. Prices are VAT excluded.

**DELIVERY TERMS:** 1. For Italy, possible shipment within 24 hours for machines in stock. 2. For machines to be produced, please allow approximately 25 days, barring unforeseen circumstances.

**SHIPMENT:** EX WORKS, goods travel at the customer's risk, therefore Fimar S.p.a. is not responsible for any damage suffered by the goods during transport. Any claims must be made at the time of delivery within the legal terms.

**TECHNICAL ASSISTANCE:** charged to the dealer for the entire duration of the warranty of one year. Fimar S.p.a. undertakes to supply, under warranty, all spare parts deemed defective. The sales price invoiced to the end user shall include not only the price of the finished products sold, but also the dealer's handling of the warranty covering them. Fimar S.p.a. shall not incur any direct or indirect expenses borne by the retailer for the management of the warranty. The warranty shall be void if the product is damaged or impaired by incorrect or otherwise non-compliant use.

**INSTALLATION:** installation and instruction in the use of the machine and its accessories are the responsibility of the dealer.

**REPAIRS:** in the event that a repair quote is not accepted, € 25.00 will be charged as a contribution towards operating costs.

**WARRANTY:** 12 months.

**RETURNS:** for any authorised returns of goods with undamaged packaging, a fee of 15% of the value will be withheld, with a minimum of € 50.

**INSURANCE:** all our machines are covered by insurance (third party liability) Excluding U.S.A. and CANADA.

**CATALOGUE:** this document invalidates all previous ones. The technical data, illustrations and pictures in this document are purely indicative. The Company reserves the right to modify the technical and aesthetic characteristics or discontinue its production at any time without prior notice.

**IMAGES AND ILLUSTRATIONS:** All images taken by the manufacturer are covered by copyright. Their use or reproduction is subject to authorisation by the company that owns the trademark and holds the material and intellectual property rights. Prices or technical data may be subject to change in the event of typographical errors or changes.

**TRADEMARK AND PATENTS:** It is expressly forbidden to use the trademarks and/or patents registered by Fimar S.p.a.. Please note that all machinery and accessories that are not CE marked have specific characteristics that make them unsuitable for sale within the countries of the European Union.

**REQUEST FOR ADDITIONAL TECHNICAL DOCUMENTATION:** Copy conforming to the original of the CE Certification: € 20.00 + shipping costs - Hard copy of the Use and Maintenance Manual: € 40.00 + shipping costs.

MOD140V05 - PRINTED IN SEPTEMBER 2025

FR

**FRAIS D'EMBALLAGE:** inclus dans le prix des machines. Pour les pièces détachées et les accessoires, il faut compter une contribution de 8,00 €; pour la caisse en bois pour les plaques réfractaires avec couvercle, la contribution est de 54,00 €.

**FRAIS FIXES DE GESTION DES COMMANDES:** 10,00 € uniquement pour les commandes inférieures à 100,00 €.

**COMMANDES:** Les commandes doivent être transmises uniquement par écrit; les nouvelles commandes ou les modifications transmises oralement ne seront pas acceptées.

**CONDITIONS DE PAIEMENT:** Le paiement par virement bancaire est exigé pour: 1. les premières livraisons - 2. en cas de dépassement de la limite de crédit - 3. L'envoi de pièces détachées.

**RETARDS DE PAIEMENT:** à définir.

Les sommes payées en retard par rapport à la date d'échéance convenue sont majorées d'un intérêt au taux légal. Les avoirs éventuels seront déduits de la facture suivante.

**PRIX:** ils ne sont pas contractuels, ils peuvent varier sans préavis, auquel cas ils seront confirmés lors de la commande. Tous les prix s'entendent hors TVA.

**CONDITIONS DE LIVRAISON:** 1) Pour l'Italie, expédition possible dans les 24 heures pour les machines en stock. 2) Pour les machines à produire, il faut compter environ 25 jours, sauf imprévus.

**TRANSPORT:** EX WORKS, la marchandise voyage aux risques et périls du client, par conséquent Fimar S.p.a. n'est pas responsable des éventuels dommages subis par la marchandise pendant le transport. Toute réclamation doit être faite au moment de la livraison dans les délais légaux.

**ASSISTANCE TECHNIQUE:** à la charge du revendeur pendant toute la durée de la garantie d'un an. Fimar S.p.a. s'engage à fournir, sous garantie, toutes les pièces de rechange jugées défectueuses. Le prix de vente facturé à l'utilisateur final comprend non seulement le prix des produits finis vendus, mais aussi la prise en charge par le revendeur de la garantie qui les couvre. Fimar S.p.a. ne supportera pas les frais directs ou indirects encourus par le revendeur pour la gestion de la garantie. La garantie est annulée si le produit est endommagé ou détérioré à la suite d'une utilisation incorrecte ou non conforme.

**INSTALLATION:** l'installation et la formation à l'utilisation de l'appareil et de ses accessoires sont à la charge du revendeur.

**RÉPARATIONS:** en cas de refus d'un devis de réparation, 25,00 € seront facturés à titre de participation aux frais d'exploitation.

**GARANTIE:** 12 mois.

**RETOURS:** pour tout retour autorisé de marchandises dans un emballage intact, une retenue de 15% de la valeur sera effectuée, avec un minimum de 50 €.

**ASSURANCE:** toutes nos machines sont couvertes par une assurance (responsabilité civile), à l'exclusion des États-Unis et du Canada.

**CATALOGUE LISTE:** Ce document annule tous les documents précédents. Les données techniques, les illustrations et les photos contenues dans ce document sont purement indicatives. La société se réserve le droit de modifier les caractéristiques techniques et esthétiques ou d'arrêter la production à tout moment et sans préavis.

**IMAGES ET ILLUSTRATIONS:** Toutes les images prises par le fabricant sont couvertes par le droit d'auteur. Leur utilisation ou leur reproduction est soumise à l'autorisation de la société propriétaire de la marque et détentrice des droits matériels et de propriété intellectuelle. Les prix ou les données techniques peuvent être modifiés en cas d'erreurs typographiques ou de changements.

**MARQUES ET BREVETS:** Il est expressément interdit d'utiliser les marques et/ou les brevets déposés par Fimar S.p.a.. Il est à noter que les machines et les accessoires non marqués CE présentent des caractéristiques spécifiques qui les rendent impropres à la vente dans les pays de l'Union européenne.

**DEMANDE DE DOCUMENTATION TECHNIQUE SUPPLÉMENTAIRE:** Copie conforme à l'original de la certification CE: 20,00 € + frais d'expédition - Copie papier du manuel d'utilisation et d'entretien: 40,00 € + frais d'expédition.

MOD140V05 - IMPRESSION TERMINÉE EN SEPTEMBRE 2025

## DE

**VERPACKUNGSKOSTEN:** im Gerätepreis enthalten. Für Ersatzteile und Zubehör werden 8,00 € als Beitrag erhoben; für die Holzkiste für feuerfeste Platten mit Deckel beträgt der Beitrag 54,00 €.

**FESTE KOSTEN FÜR DIE BESTELLUNGSVERWALTUNG:** 10,00 € nur für Bestellungen unter 100,00 €.

**AUFTRÄGE:** Aufträge sind ausschließlich in schriftlicher Form zu übermitteln; mündlich übermittelte Neuaufträge oder Änderungen werden nicht angenommen.

**ZAHLUNGSBEDINGUNGEN:** Die Zahlung per Banküberweisung ist erforderlich: 1. bei der ersten Lieferung. - 2. bei Überschreitung des Kreditlimits. - 3. bei Versand von Ersatzteilen.

**ZAHLUNGSVERZÖGERUNGEN:** zu bestimmen.

Auf verspätet gezahlte Beträge werden Verzugszinsen in Höhe des gesetzlichen Zinssatzes erhoben. Eventuelle Gutschriften werden mit der nächsten Rechnung verrechnet.

**PREISE:** Sie sind unverbindlich und können ohne vorherige Ankündigung geändert werden; in diesem Fall werden sie auf der Bestellung bestätigt. Alle Preise verstehen sich ohne Mehrwertsteuer.

**LIEFERBEDINGUNGEN:** 1. für Italien, möglicher Versand innerhalb von 24 Stunden für Geräte auf Lager. 2) Für Geräte, die hergestellt werden sollen, beträgt die Lieferzeit etwa 25 Tage, sofern keine unvorhergesehenen Umstände eintreten.

**TRANSPORT:** AB WERK, die Ware reist auf Risiko des Kunden, daher ist Fimar S.p.a. nicht für eventuelle Schäden an der Ware während des Transports verantwortlich. Eventuelle Reklamationen müssen zum Zeitpunkt der Lieferung innerhalb der gesetzlichen Fristen geltend gemacht werden.

**TECHNISCHE UNTERSTÜTZUNG:** zu Lasten des Händlers für die gesamte Dauer der Garantie von einem Jahr. Fimar S.p.a. verpflichtet sich, im Rahmen der Garantie alle Ersatzteile zu liefern, die als defekt gelten. Der dem Endverbraucher in Rechnung gestellte Verkaufspreis umfasst nicht nur den Preis für die verkauften Endprodukte, sondern auch die Abwicklung der Garantie durch den Händler. Fimar S.p.a. übernimmt keine direkten oder indirekten Kosten, die dem Wiederverkäufer durch die Abwicklung der Garantie entstehen. Die Garantie erlischt, wenn das Produkt durch unsachgemäßen oder anderweitig nicht konformen Gebrauch beschädigt oder beeinträchtigt wird.

**INBETRIEBNAHME:** Die Inbetriebnahme und die Einweisung in den Gebrauch des Geräts und seines Zubehörs liegen in der Verantwortung des Händlers.

**REPARATUREN:** Falls ein Kostenvoranschlag für eine Reparatur nicht akzeptiert wird, werden 25,00 € als Beitrag zu den Betriebskosten berechnet.

**GARANTIE:** 12 Monate.

**RÜCKGABE:** Für jede genehmigte Rücksendung von Waren mit unbeschädigter Verpackung wird eine Gebühr von 15 % des Wertes einbehalten, mindestens jedoch 50 €.

**VERSICHERUNG:** Alle unsere Geräte sind versichert (Haftpflicht), ausgenommen USA und CANADA.

**KATALOG-PREISLISTE:** Dieses Dokument ersetzt alle vorherigen Dokumente. Die technischen Daten, Illustrationen und Bilder in diesem Dokument sind rein indikativ. Das Unternehmen behält sich das Recht vor, die technischen und ästhetischen Merkmale zu ändern oder die Produktion jederzeit und ohne Vorankündigung einzustellen.

**BILDER UND ILLUSTRATIONEN:** Alle vom Hersteller aufgenommenen Bilder sind urheberrechtlich geschützt. Ihre Verwendung oder Vervielfältigung unterliegt der Genehmigung des Unternehmens, das Eigentümer der Marke und Inhaber der materiellen und geistigen Eigentumsrechte ist. Preise oder technische Daten können im Falle von Druckfehlern oder Änderungen geändert werden.

**MARKEN UND PATENTE:** Es ist ausdrücklich verboten, die von Fimar S.p.a. eingetragenen Marken und/oder Patente zu verwenden. Wir weisen darauf hin, dass alle Maschinen und Zubehörteile, die nicht mit der CE-Kennzeichnung versehen sind, besondere Merkmale aufweisen, die sie für den Verkauf in den Ländern der Europäischen Union ungeeignet machen.

**ANFORDERUNG VON ZUSÄTZLICHEN TECHNISCHEM DOKUMENTEN:** Kopie, die dem Original der CE-Zertifizierung entspricht: € 20,00 + Versandkosten - Ausdruck der Bedienungs- und Wartungsanleitung: € 40,00 + Versandkosten.

MOD140V05 - FDRUCKFERTIGSTELLUNG IM SEPTEMBER 2025

## ES

**GASTOS DE EMBALAJE:** incluidos en el precio de los equipos. Para las piezas de repuesto y accesorios hay una contribución de 8,00 €; caja de madera para placas refractarias con tapa la contribución es de 54,00 €.

**GASTOS FIJOS DE GESTIÓN DE PEDIDOS:** 10,00 euros sólo para pedidos inferiores a 100,00 euros.

**PEDIDOS:** Los pedidos deben transmitirse únicamente por escrito; no se aceptarán nuevos pedidos ni modificaciones transmitidas verbalmente.

**CONDICIONES DE PAGO:** El pago por transferencia bancaria es obligatorio para: 1. Primeras entregas. - 2. Al superar el límite de crédito. - 3. Envío de piezas de recambio.

**ATRASOS EN EL PAGO:** A definir.

Se cobrarán intereses al tipo legal sobre las cantidades pagadas con retraso respecto a la fecha de vencimiento acordada. Los abonos se descontarán de la siguiente factura.

**PRECIOS:** no son vinculantes, pueden variar sin previo aviso, en cuyo caso se confirmarán en el pedido. Todos los precios son sin IVA.

**PLAZOS DE ENTREGA:** 1. Para Italia, envío posible en 24 horas para las máquinas en stock. 2. Para las máquinas que deben fabricarse, prevea un plazo aproximado de 25 días, salvo imprevistos.

**TRANSPORTE:** FRANCO DE PORTE, la mercancía viaja por cuenta y riesgo del cliente, por lo que Fimar S.p.a. no se hace responsable de los posibles daños sufridos por la mercancía durante el transporte. Cualquier reclamación deberá efectuarse en el momento de la entrega dentro de los plazos legales.

**ASISTENCIA TÉCNICA:** a cargo del concesionario durante toda la duración de la garantía de un año. Fimar S.p.a. se compromete a suministrar, en garantía, todas las piezas de recambio consideradas defectuosas. El precio de venta facturado al usuario final incluirá no sólo el precio de los productos acabados vendidos, sino también la gestión por parte del concesionario de la garantía que los cubre. Fimar S.p.a. no incurrirá en ningún gasto directo o indirecto ocasionado al revendedor por la gestión de la garantía. La garantía quedará anulada si el producto resulta dañado o perjudicado por un uso incorrecto o no conforme.

**INSTALACIÓN:** la instalación y la instrucción en el uso de la máquina y sus accesorios son responsabilidad del distribuidor.

**REPARACIONES:** en caso de que no se acepte un presupuesto de reparación, se cobrarán 25,00 euros como contribución a los gastos de funcionamiento.

**GARANTÍA:** 12 meses.

**DEVOLUCIONES:** para cualquier devolución autorizada de mercancía con el embalaje intacto, se deducirá una tasa del 15% del valor, con un mínimo de 50 euros.

**SEGURO:** todas nuestras máquinas están cubiertas por un seguro (responsabilidad civil), excepto EE.UU. y CANADÁ.

**CATÁLOGO/LISTA:** este documento anula todos los anteriores. Los datos técnicos, ilustraciones y fotografías que figuran en este documento son puramente indicativos. La Empresa se reserva el derecho de modificar las características técnicas y estéticas o de interrumpir su producción en cualquier momento sin previo aviso.

**IMÁGENES E ILUSTRACIONES:** Todas las imágenes tomadas por el fabricante están protegidas por derechos de autor. Su utilización o reproducción está sujeta a la autorización de la empresa propietaria de la marca y titular de los derechos materiales y de propiedad intelectual. Los precios o datos técnicos pueden estar sujetos a modificaciones en caso de errores tipográficos o cambios.

**MARCAS Y PATENTES:** Queda expresamente prohibida la utilización de las marcas y/o patentes registradas por Fimar S.p.a.. Se recuerda que todas las máquinas y accesorios que no llevan el marcado CE tienen características específicas que los hacen inadecuados para la venta en los países de la Unión Europea.

**SOLICITUD DE DOCUMENTACIÓN TÉCNICA ADICIONAL:** Copia conforme al original de la Certificación CE: 20,00 € + gastos de envío - Copia impresa del Manual de Uso y Mantenimiento: 40,00 € + gastos de envío.

MOD140V05 - ACABADO DE IMPRIMIR EN SEPTIEMBRE DE 2025

## RU

**РАСХОДЫ НА УПАКОВКУ:** Включены в стоимость оборудования. Запасные части и аксессуары оплачиваются дополнительно в размере €8,00. Деревянный ящик для огнеупорных плит с крышкой оплачивается дополнительно в размере 54,00 евро.

**ФИКСИРОВАННАЯ СТОИМОСТЬ УПРАВЛЕНИЯ ЗАКАЗОМ:** € 10,00 только для заказов на сумму менее € 100,00.

**ЗАКАЗЫ:** Заказы должны передаваться только в письменной форме; новые заказы или любые изменения, переданные в устной форме, не принимаются.

**УСЛОВИЯ ОПЛАТЫ:** Оплата банковским переводом требуется для: 1. при первых поставках. - 2. при превышении кредитного лимита. - 3. Отгрузки запасных частей.

**ОТЛОЖЕНИЯ ОПЛАТЫ:** определяются дополнительно.

На суммы, выплаченные с опозданием по отношению к оговоренной дате платежа, начисляются проценты по установленной законом ставке. Любые кредитные ноты будут вычитаться из следующего счета-фактуры.

**ЦЕНЫ:** цены не являются обязательными, они могут изменяться без предварительного уведомления, в этом случае они будут подтверждены в заказе. Все цены указаны без учета НДС.

**УСЛОВИЯ ДОСТАВКИ:** 1. Для Италии возможна отгрузка в течение 24 часов для станков, имеющихся на складе. 2. для машин, которые должны быть произведены, пожалуйста, приготовьте примерно 25 дней, за исключением непредвиденных обстоятельств.

**ТРАНСПОРТИРОВКА:** БЕСПЛАТНАЯ ДОСТАВКА, товар перевозится на риск покупателя, поэтому Fimar S.p.a. не несет ответственности за любой ущерб, нанесенный товару во время транспортировки. Любые претензии должны быть предъявлены в момент доставки в рамках установленных законом сроков.

**ТЕХНИЧЕСКОЕ ОБСЛУЖИВАНИЕ:** оплачивается дилером в течение всего срока действия гарантии, составляющего один год. Fimar S.p.a. обязуется поставлять по гарантии все запасные части, признанные дефектными. В цену продажи, выставленную конечному пользователю, включается не только стоимость проданных готовых изделий, но и расходы дилера на гарантийное обслуживание этих изделий. Компания Fimar S.p.a. не несет никаких прямых или косвенных расходов, понесенных торговым представителем в связи с управлением гарантией. Гарантия теряет силу, если изделие повреждено или вышло из строя в результате неправильного или иного несоответствующего использования.

**УСТАНОВКА:** за установку и инструктаж по эксплуатации машины и ее принадлежностей отвечает дилер.

**РЕМОНТ:** в случае неприятия сметы на ремонт взимается 25,00 евро в качестве взноса на эксплуатационные расходы.

**ГАРАНТИЯ:** 12 месяцев.

**ВОЗВРАТ:** за любой разрешенный возврат товара с неповрежденной упаковкой удерживается сбор в размере 15% от стоимости, минимальная сумма составляет € 50.

**СТРАХОВАНИЕ:** все наши машины застрахованы (ответственность перед третьими лицами), за исключением США и Канады.

**КАТАЛОГ/ПЕРЕЧЕНЬ:** данный документ отменяет все предыдущие. Технические данные, иллюстрации и фотографии, приведенные в данном документе, являются исключительно ориентировочными. Компания оставляет за собой право изменять технические и эстетические характеристики или прекращать его производство в любое время без предварительного уведомления.

**ИЗОБРАЖЕНИЯ И ИЛЛЮСТРАЦИИ:** Все изображения, сделанные производителем, защищены авторским правом. Их использование или воспроизведение осуществляется с разрешения компани- владельца товарного знака и прав на материалы и интеллектуальную собственность. Цены или технические данные могут быть изменены в случае опечаток или изменений.

**ТОРГОВЫЕ ЗНАКИ И ПАТЕНТЫ:** Категорически запрещается использовать торговые марки и/или патенты, зарегистрированные компанией Fimar S.p.a. Обратите внимание, что все машины и принадлежности, не имеющие маркировки CE, обладают специфическими характеристиками, которые делают их непригодными для продажи на территории стран Европейского Союза.

**ЗАПРОС ДОПОЛНИТЕЛЬНОЙ ТЕХНИЧЕСКОЙ ДОКУМЕНТАЦИИ:** Копия, соответствующая оригиналу сертификата CE: € 20,00 + стоимость доставки - Твердая копия руководства по эксплуатации и техническому обслуживанию: € 40,00 + стоимость доставки.

MOD140V05 - ГОТОВО К ПЕЧАТИ В СЕНТЯБРЕ 2025

BLO20S  
BLO20BN  
BLO10

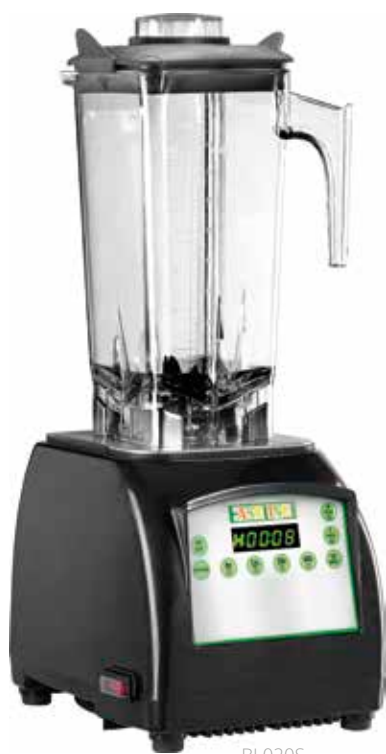

BLO20S



BLO20BN



BLO10

Frullatori

MIXERS  
BLENDERS  
MIXERS  
LICUADORA  
БЛЕНДЕРЫ

IT Macchine per la preparazione di frullati - bicchiere in lexan trasparente da 2 L - microinterruttore di sicurezza sul bicchiere - coltello a 4 lame in acciaio inox - tappo sul coperchio per aggiungere ingredienti in fase di lavorazione. BL020S: carcassa in plastica - motore a due velocità - 4 programmi memorizzati (8-12-30-60") - tasto "pulse" lento e veloce - tasto tritaggiaccio. BL020BN: carcassa in plastica cromata - regolatore di velocità - tasto "pulse". BL010: carcassa in plastica - regolatore di velocità - tasto "pulse".











EN Smoothie blender - 2 L transparent lexan cup - safety microswitch on the cup - 4-blade stainless steel knife - cap on the lid for adding ingredients while working. BL020S: plastic casing - two-speed motor - 4 stored programmes (8-12-30-60") - slow and fast "pulse" button - ice crusher button. BL020BN: chrome-plated plastic casing - speed regulator - "pulse" button. BL010: plastic casing - speed regulator - "pulse" button.

FR Machine pour la préparation de smoothies - récipient transparent en lexan de 2 L - micro-interrupteur de sécurité sur le récipient - couteau à 4 lames en acier inox - capuchon sur le couvercle pour ajouter des ingrédients en cours de travail. BL020S: corps en plastique - moteur à 2 vitesses - 4 programmes mémorisés (8-12-30-60") - bouton d'impulsion lente et rapide - bouton broyeur de glace. BL020BN: corps en plastique chromé - régulateur de vitesse - bouton "pulse". BL010: corps en plastique - régulateur de vitesse - bouton "pulse".

DE Maschine für die Zubereitung von Smoothies - 2-Liter-Behälter aus transparentem Lexan - Sicherheitsmikroschalter am Becher - 4-Klingen-Edelstahlmesser - Deckel zum Hinzufügen von Zutaten während der Arbeit. BL020S: Kunststoffgehäuse - Motor mit 2 Geschwindigkeiten - 4 gespeicherte Programme (8-12-30-60") - langsame und schnelle Pulstaste - Eiszerkleinerungstaste. BL020BN: verchromtes Kunststoffgehäuse - Geschwindigkeitsregler - "Pulse"-Taste. BL010: Kunststoffgehäuse - Geschwindigkeitsregler - "Pulse"-Taste.

ES Máquina para preparar batidos - vaso de lexan transparente de 2 L - microinterruptor de seguridad en el vaso - cuchilla de acero inoxidable de 4 hojas - tapón en la tapa para añadir ingredientes mientras trabaja. BL020S: carcasa de plástico - motor de dos velocidades - 4 programas memorizados (8-12-30-60") - botón de pulsación lenta y rápida - botón triturador de hielo. BL020BN: carcasa de plástico cromado - regulador de velocidad - botón "pulse". BL010: carcasa de plástico - regulador de velocidad - botón "pulse".

RU Машина для приготовления смузи - прозрачный стакан из лексана объемом 2 л - предохранительный микровыключатель на стакане - 4-лопастной нож из нержавеющей стали - пробка на крышке для добавления ингредиентов во время работы. BL020S: пластиковый корпус - двухскоростной мотор - 4 сохраненные программы (8-12-30-60") - кнопка медленного и быстрого импульса - кнопка измельчения льда. BL020BN: хромированный пластиковый корпус - регулятор скорости - кнопка "импульс". BL010: пластиковый корпус - регулятор скорости - кнопка "импульс".

	BL020S	BL020BN	BL010
			
	1,5 kW		
	230V/1N/50-60Hz		
	28000 rpm	25000 rpm	
	2 L		
	200 x 260 x 520(h) mm	190 x 220 x 490(h) mm	205 x 230 x 510(h) mm
			
	5 Kg	4,2 Kg	4,3 Kg
	6 Kg	5,2 Kg	5,3 Kg
	330 x 260 x 530(h) mm		340 x 255 x 515(h) mm
	0,045 m³		

BINOX	
Bicchiere in acciaio inox - Stainless steel cup - Récipient acier inox Edelstahlbecher - Vaso de acero inoxidable - Нержавеющая сталь Стекло	
	

DMB  
DMB20



Frullatori frappe'

MILKSHAKER  
BLENDERS À FRAPPÉS  
MILKSHAKERS  
LICUADORA FRAPPÉ  
БЛЕНДЕРЫ ДЛЯ ПРИГОТОВЛЕНИЯ ФРАППЕ

- IT** Macchina per realizzare frappè, cocktails, sorbetti, ecc. Base e corpo motore in alluminio, colonna in acciaio inox - bicchiere in acciaio inox da 0,8 L - sistema di accensione automatica solo con bicchiere inserito.
- EN** Machine to prepare milkshakes, cocktails, Sorbet, etc. Base and motor unit in aluminium, pole in stainless steel - 0,8 L Stainless steel cup - automatic ignition system only with inserted cup.
- FR** Appareil permettant de préparer des frappés, cocktails, sorbets, etc. Base et corps moteur en aluminium, colonne en acier inox - récipient de 0,8 L en acier inox - système de démarrage automatique uniquement si le récipient est inséré.
- DE** Maschine zur Herstellung von Milchshakes, Cocktails, Sorbets, etc. Sockel und Motorkörper aus Aluminium, Säule aus Edelstahl - 0,8 L Becher aus Edelstahl - automatisches Einschaltungssystem nur bei eingesetztem Becher.
- ES** Máquina para preparar batidos, coctéles, sorbetes, etc. Base y cuerpo motor de aluminio, columna de acero inoxidable - vaso (capacidad 0,8 litros) de acero inoxidable - sistema de encendido automático sólo si el vaso está enchanchado.
- RU** Машина для приготовления молочных коктейлей, коктейлей, сорбента и т.д. Базовый блок и моторный блок из алюминия, стойка из бесстатистической стали - 0,8 л. Чашка из нержавеющей стали - автоматическая система зажигания только со вставленной чашкой.

	<b>DMB</b>	<b>DMB20</b>
	0,4 kW	0,4 + 0,4 kW
	230V/1N/50-60Hz	
	16000 rpm	16000 + 16000 rpm
	0,8 L	0,8 + 0,8 L
	200 x 230 x 500(h) mm	330 x 160 x 500(h) mm
		
	3,6 Kg	7,5 Kg
	4,5 Kg	9 Kg
	300 x 260 x 530(h) mm	600 x 260 x 530(h) mm
	0,042 m³	0,083 m³



# TM905 + Q109



TM905













Q109

Frullatore  
con funzione cottura

MIXER WITH COOKING FUNCTION  
MIXEUR AVEC FONCTION CUISSON  
MIXER MIT KOCHFUNKTION  
LICUADORA CON FUNCIÓN DE COCCIÓN  
МЕШАЛКА С ФУНКЦИЕЙ ПРИГОТОВЛЕНИЯ ПИЩИ

- IT** Macchina per la preparazione di zuppe, riduzioni e salse. Pannello touch screen con programmi pre-impostati.  
TM905+Q109: macchina compresa di cutter manuale - bicchiere in vetro.
- EN** The ideal machine to prepare soups, reductions and sauces. Touch screen panel with pre-set programs.  
TM905+Q109: the machine is equipped with a manual cutter and a glass cup.
- FR** Machine pour la préparation de soupes, réductions et sauces. Ecran tactile avec programmes prédéfinis.  
TM905+Q109: machine avec découpeur manuel - récipient en verre.
- DE** Suppen-, Reduktions- und Saucenzubereitungsmaschinen. Touchscreen-Bedienfeld mit voreingestellten Programmen.  
TM905+Q109: maschine mit Handschneider - Glasbecher.
- ES** Máquina para preparar sopas, reducciones y salsas. Panel "touch screen" con programas preestablecidos.  
TM905+Q109: máquina que incluye un cutter manual - vaso de vidrio.
- RU** Идеальные машины для приготовления супов, редукторов и соусов. Сенсорная панель с предустановленными программами.  
TM905+Q109: машина оснащена ручным резакom и стеклянной чашкой.

TM905 + Q109		
	1 kW	0,2 kW
 1 Ph	230V/1N/50-60Hz	
HEATING POWER	1,2 kW	-
	Max 100°C	-
 RPM	26000 rpm	24000 rpm
	1,75 L	1,2 L
 mm	250 x 195 x 503(h) mm	225 x 206 x 267(h) mm
		
 Kg	7,5 Kg	
 Kg	10,8 Kg	
 mm	467 x 467 x 327(h) mm	
 m <sup>3</sup>	0,071 m <sup>3</sup>	

FT901MD  
LSG8

New

DISPONIBILE DA  
AVAILABLE FROM 01/2026

4 L



FT901MD



LSG8

Frullatore  
con insonorizzatore

MIXER WITH SOUND-PROOFER  
MÉLANGEUR AVEC INSONORISATION  
MIXER MIT SCHALLSCHUTZ  
LICUADORA CON INSONORIZADOR  
СМЕСИТЕЛИ СО ЗВУКОИЗОЛЯЦИЕЙ

**IT** Macchina per preparare frullati e frappè con insonorizzatore.  
 FT901MD: Pannello con possibilità di 5 programmi preimpostati - insonorizzatore integrato nel basamento della macchina - 10 velocità possibili - bicchiere in lexan trasparente da 2 L.  
 LSG8: Insonorizzatore integrato nel basamento della macchina - 9 velocità possibili - bicchiere in lexan trasparente da 4 L.

**EN** Smoothie and milkshake blender with soundproofing.  
 FT901MD: Panel with the possibility of 5 pre-set programmes - integrated soundproofing in the machine base - 10 possible speeds - 2 L transparent lexan cup.  
 LSG8: Integrated soundproofing in the machine base - 9 possible speeds - 4 L transparent lexan cup.

**FR** Machine pour la préparation de smoothies et de laits frappés avec insonorisation.  
 FT901MD: Panneau avec possibilité de 5 programmes pré-réglés - insonorisation intégrée dans la base de la machine - 10 vitesses possibles - 2 L de récipient lexan transparent.  
 LSG8: Insonorisation intégrée dans la base de la machine - 9 vitesses possibles - 4 L de récipient lexan transparent.

**DE** Maschine für die Zubereitung von Smoothies und Milch-shakes mit Schalldämmung.  
 FT901MD: Panel mit der Möglichkeit von 5 voreingestellten Programmen - integrierte Schalldämmung im Maschinenfuß - 10 mögliche Geschwindigkeiten - 2 L transparentes Lexanglas.  
 LSG8: Integrierte Schalldämmung im Maschinenfuß - 9 mögliche Geschwindigkeiten - 4 L transparentes Lexanglas.

**ES** Máquina para hacer batidos y smoothies con insonorización.  
 FT901MD: Panel con posibilidad de 5 programas preestablecidos - Insonorización integrada en la base de la máquina - 10 velocidades posibles - Vaso de lexan transparente de 2 L.  
 LSG8: Insonorización integrada en la base de la máquina - 9 velocidades posibles - Vaso de lexan transparente de 4 L.

**RU** Машина для приготовления смузи и молочных кок-тейлей со звуко-золяцией.  
 FT901MD: Панель с возможностью 5 предустановленных программ - встроенная звуко-золяция в основание машины - 10 возможных скоростей - прозрачное лексановое стекло объемом 2 л.  
 LSG8: встроенная звуко-золяция в основание машины - 9 возможных скоростей - прозрачное лексановое стекло объемом 4 л.

	FT901MD	LSG8
		
	1,8 kW	2,2 kW
	230V/1N/50-60Hz	
	28000 rpm	32000 rpm
	2 L	4 L
	200 x 230 x 500(h) mm	240 x 260 x 580(h) mm
		
	7,5 Kg	9 Kg
	8 Kg	10 Kg
	550 x 300 x 300(h) mm	370 x 290 x 610(h) mm
	0,0495 m³	0,066 m³



**New**

PB009  
PU008



# Estrattore di succhi

SLOW JUICER  
EXTRACTEUR DE JUS  
SAFTPRESSE  
EXTRACTOR DE ZUMO  
СЛОВ ДЖУЙСЕР

**IT** Macchine per ottenere succhi di frutta e verdura mantenendo intatti gli elementi nutritivi naturalmente presenti nel cibo grazie al sistema di estrazione a bassa velocità (slow juicer). Struttura in acciaio inox e plastica idonea agli alimenti - espulsione automatica della polpa. In dotazione 2 contenitori in plastica per gli scarti e per il succo, 1 filtro, box per la preparazione del tofu, spazzolino per la pulizia, 3 filtri in acciaio inox.  
 PB009: esclusivo imbuto a bocca larga che permette l'introduzione di frutta e verdura intere, senza bisogno di sminuzzarle grazie ad una dimensione della bocca di  $\varnothing$  80 mm.  
 PU008: tasto funzione reverse per una facile e veloce pulizia - dimensione della bocca  $\varnothing$  40 mm.

**EN** Machine to obtain fruit and vegetable juices while keeping intact the nutrients naturally present in the food thanks to the slow juicer system. Casing in stainless steel and plastic suitable for food - automatic pulp ejection. Supplied with 2 plastic containers for waste and juice, 1 filter, box for the preparation of tofu, cleaning brush, 3 stainless steel filters.  
 PB009: Extremely wide inlet funnel that allows the introduction of whole fruits and vegetables, with no need to cut them into pieces thanks to an inlet size of  $\varnothing$  80 mm.  
 PU008: reverse function switch for quick and easy cleaning - inlet size  $\varnothing$  40 mm.

**FR** Machines pour obtenir des jus de fruits et de légumes tout en conservant intacts les nutriments naturellement présents dans l'aliment grâce au système d'extraction à basse vitesse (slow juicer). Corps en acier inox et en plastique alimentaire - expulsion automatique de la pulpe. Livré avec 2 récipients en plastique pour les déchets et le jus, 1 filtre, boîte pour la préparation du tofu, brosse pour le nettoyage, 3 filtres en acier inox.  
 PB009: Entonnoir à grande orifice qui permet l'introduction de fruits et légumes entiers, sans devoir les écraser grâce à une ouverture de  $\varnothing$  80 mm.  
 PU008: touche de fonction inverse pour un nettoyage rapide et  $\varnothing$  40 mm.

**DE** Maschinen zur Zubereitung von Frucht- und Gemüsesäften unter Beibehaltung der natürlichen Nährstoffe durch das langsame Extraktionssystem (Slow Juicer). Edelstahl- und lebensmitteltauglich Kunststoffgehäuse - automatisches Ausstoßen der Pulpe. Ausgestattet mit 2 Kunststoffbehältern für Abfall und Saft, 1 Filter, Box zur Zubereitung von Tofu, Bürste zur Reinigung, 3 Edelstahlfilter.  
 PB009: Exklusiver Trichter mit extra Größe Einfuhröffnung, zur Einführung von ganzen Obst und Gemüse, ohne vorheriges Zerkleinern, dank einer Öffnungsweite von  $\varnothing$  80 mm.  
 PU008: Umkehrfunktionstaste für schnelle und einfache Reinigung - Einführungsöffnungsgröße  $\varnothing$  40 mm.

**ES** Máquinas para la preparación de zumos de frutas y verduras manteniendo los nutrientes naturales a través del sistema de extracción lenta (Slow Juicer). Carcasa de acero inoxidable y plástico apto para uso alimentario - Expulsión automática de la pulpa. Equipado con 2 contenedores de plástico para residuos y zumos, 1 filtro, caja para la preparación de tofu, cepillo para la limpieza, 3 filtros de acero inoxidable.  
 PB009: Embudo exclusivo con abertura de entrada extremadamente grande, para la introducción de frutas y hortalizas enteras, sin trituración previa, gracias a un ancho de abertura de  $\varnothing$  80 mm.  
 PU008: tecla de función de reversa para una limpieza rápida y fácil - tamaño de la boca  $\varnothing$  40 mm.

	<b>PB009</b>	<b>PU008</b>
	0,4 kW	0,25 kW
	230V/1N/50-60Hz	
	37 rpm	45 rpm
	250 x 160 x 450(h) mm	150 x 250 x 450(h) mm
		
	9 Kg	7,5 Kg
	10 Kg	10 Kg
	340 x 370 x 290(h) mm	390 x 305 x 330(h) mm
	0,036 m³	0,040 m³

**RU** Машины для приготовления фруктовых и овощных соков с сохранением натуральных питательных веществ благодаря системе медленной экстракции (Slow Juicer). Корпус из нержавеющей стали и пищевого пластика - автоматический выброс отходов. Оснащен 2 пластиковыми контейнерами для отходов и сока, 1 фильтром, коробкой для приготовления тофу, щеткой для очистки, 3 фильтрами из нержавеющей стали.  
 PB009: Эксклюзивная воронка с чрезвычайно большим входным отверстием, для вставки цельных фруктов и овощей, без предварительного дробления, благодаря ширине отверстия  $\varnothing$  80 мм.  
 PU008: обратная функциональная клавиша для быстрой и легкой чистки - размер рта  $\varnothing$  40 мм.

CJ900A  
PC700

PROFESSIONAL



CJ900A



PC700

Centrifughe

CENTRIFUGES  
CENTRIFUGEUSES  
ZENTRIFUGEN  
LICUADORA CENTRÍFUGA  
ЦЕНТРИФУГИ

IT Macchine per realizzare centrifugati di frutta e verdura - struttura in acciaio inox e plastica idonea al contatto con gli alimenti - espulsione automatica della polpa - contenitore scarti in plastica - microinterruttore di sicurezza su aggancio coperchio superiore - vasca, filtro e disco in acciaio inox.  
PC700: dimensione bocca  $\varnothing$  70 mm.  
CJ900A: dimensione bocca  $\varnothing$  80 mm.

EN Machines designed to produce fruit and vegetable centrifuges - casing made of stainless steel and plastic suitable for contact with food - automatic pulp ejection - plastic waste container - safety microswitch on upper lid fastening - stainless steel bowl, filter and disk.  
PC700: inlet size  $\varnothing$  70 mm.  
CJ900A: inlet size  $\varnothing$  80 mm.

FR Machines pour la préparation de produits centrifugés à base de fruits et légumes - corps en acier inox et plastique apte au contact alimentaire - éjection automatique de la pulpe - récipient pour les déchets en plastique - microrupteur de sécurité sur le couvercle supérieur - cuve, filtre et disque en acier inox.  
PC700: dimension orifice  $\varnothing$  70 mm.  
CJ900A: dimension orifice  $\varnothing$  80 mm.

DE Maschinen zur Herstellung von Obst- und Gemüsezentrifugen - Edelstahl- und Kunststoffstruktur geeignet für den Kontakt mit Lebensmitteln - automatischer Ausstoß der Pulpe - Kunststoffabfallbehälter - Sicherheitsmikroschalter am Oberdeckelaufsatz - Behälter, Filter und Scheibe aus Edelstahl.  
PC700: Einführöffnungsgröße  $\varnothing$  70 mm.  
CJ900A: Einführöffnungsgröße  $\varnothing$  80 mm.

ES Máquina para preparar centrifugas de frutas u hortalizas - estructura de acero inoxidable y plástico idóneo para el contacto con los alimentos - expulsión automática de la pulpa recipiente para los residuos de plástico - microinterrupor de seguridad en el enganche de la tapa - cuba, filtro y disco de acero inoxidable.  
PC700: boca de  $\varnothing$  70 mm.  
CJ900A: boca de  $\varnothing$  80 mm.

RU Машина предназначена для производства фруктовых и овощных центрифуг - корпус из нержавеющей стали и пластика, пригодный для контакта с пищевыми продуктами - автоматический выброс мякоти - пластиковый контейнер для отходов - микровыключатель безопасности на креплении верхней крышки - резервуар, фильтр и диск из нержавеющей стали.  
PC700: входной размер  $\varnothing$  70 мм.  
CJ900A: входной размер  $\varnothing$  80 мм.

	CJ900A	PC700
	0,7 kW	0,85 kW
 1 Ph	230V/1N/50-60Hz	
 RPM	3000 rpm	2800 rpm
 mm	473 x 253 x 525(h) mm	230 x 310 x 395(h) mm
		
 NET Kg	13,3 Kg	5 Kg
 GROSS Kg	15 Kg	6 Kg
 mm	490 x 280 x 520(h) mm	330 x 270 x 440(h) mm
 m <sup>3</sup>	0,070 m <sup>3</sup>	0,039 m <sup>3</sup>



SACJ4 - SACJ5  
SACJ5A - SACJ6



SACJ5A



SACJ6

Spremiagrumi

CITRUS JUICER  
PRESSE-AGRUMES  
ZITRUSPRESSE  
EXPRIMIDORES  
СОКОВЫЖИМАЛКИ ДЛЯ ЦИТРУСОВЫХ

IT Macchine per spremere agrumi.  
 SACJ4 - SACJ5: spremiagrumi elettrico in lega di alluminio verniciato - vasca, filtro, paraspruzzi e pigna in plastica estraibili - tripla pigna.  
 SACJ5A - SACJ6: spremiagrumi elettrico a leva in lega di alluminio satinato - azionamento e spegnimento tramite l'utilizzo della leva premi agrumi - vasca, filtro, pigna e paraspruzzi removibili in acciaio inox.

EN Citrus juicers.  
 SACJ4 - SACJ5: electric citrus juicer in painted aluminium alloy - removable plastic bowl, filter, backsplash and reamer - triple reamer.  
 SACJ5A - SACJ6: electric citrus juicer with lever in satin aluminium alloy - on/off by means of the citrus juicer lever - removable stainless steel bowl, filter, reamer and backsplash.

FR Machines à presser les agrumes.  
 SACJ4 - SACJ5: extracteur de jus d'agrumes électrique en alliage d'aluminium peint - cuve, filtre, dossier et cônes amovibles en plastique - triple cône.  
 SACJ5A - SACJ6: presse-agrumes électrique avec levier en alliage d'aluminium satiné - marche et arrêt par pression du levier - cuve, filtre, cône et dossier amovibles en acier inox.

DE Zitruspressenmaschinen.  
 SACJ4 - SACJ5: Elektrische Zitruspresse aus lackierter Aluminiumlegierung - abnehmbare Wanne, Filter, Spritzschutz und Kegel aus Kunststoff - Dreifachkegel.  
 SACJ5A - SACJ6: Elektrische Zitruspresse mit Hebel aus satiniertes Aluminiumlegierung - Ein- und Ausschaltung über Druckhebel - abnehmbare Wanne, Filter, Kegel und Spritzschutz aus Edelstahl.

ES Máquina para exprimir cítricos.  
 SACJ4 - SACJ5: exprimidor eléctrico de aleación de aluminio pintado - cuba, filtro, protección y conos extraíbles - 3 conos.  
 SACJ5A - SACJ6: exprimidor eléctrico (de aleación de aluminio pulido) de palanca - puesta en marcha y apagado a través de una palanca que presiona los frutos - cuba, filtro, protección y conos extraíbles y de acero inoxidable.

RU Машины для прессования цитрусовых фруктов.  
 SACJ4 - SACJ5: электрическая соковыжималка для цитрусовых из окрашенного алюминиевого сплава - бак, фильтр, люфт и съемные пластиковые конусы - тройной конус.  
 SACJ5A - SACJ6: электрическая соковыжималка для цитрусовых с рычагом из алюминиевого сплава с атласным покрытием - рычаг включения/выключения - съемный бак, фильтр, конус и спинка из нержавеющей стали.

i	SACJ4	SACJ5	SACJ5A	SACJ6
⚡	0,18 kW		0,23 kW	
1 Ph	230V/1N/50-60Hz			
RPM	1800 rpm		1450 rpm	980 rpm
mm	220 x 310 x 340(h) mm	340 x 202 x 420(h) mm	335 x 202 x 475/680(h) mm	220 x 290 x 390/585(h) mm
🚚				
NET Kg	5 Kg	5,5 Kg	8 Kg	8,7 Kg
GROSS Kg	5,5 Kg	6,5 Kg	8,8 Kg	9,7 Kg
mm	310 x 220 x 360(h) mm	360 x 260 x 460(h) mm	380 x 240 x 510(h) mm	360 x 280 x 470(h) mm
m³	0,024 m³	0,042 m³	0,047 m³	



SACJ4

SACJ5

# RMS20



RMS20













**DISPONIBILE DA  
AVAILABLE FROM 01/2026**

**New**

## Impastatrice a bracci tuffanti

MIXER WITH PLUNGING ARMS  
MÉLANGEUR À BRAS PLONGEANTS  
MISCHER MIT TAUCHARMEN  
AMASADORA CON BRAZOS SUMERGIBLES  
МИКСЕР С ПОГРУЖНЫМИ РЫЧАГАМИ

- IT** Macchina per diversi tipi di impasto quali pizza, pane, biscotti, croissant, brioches, bignè, pan di spagna, pasta frolla. Struttura in acciaio inox - vasca e bracci in acciaio inox AISI 304 - coperchio vasca in PET trasparente con foro per aggiunta ingredienti in fase di lavorazione - regolatore di velocità da 1 a 5 - timer digitale - bracci inox smontabili per un'efficace pulizia con incastro a baionetta.
- EN** Machine for different types of dough such as pizza, bread, biscuits, croissants, brioches, cream puffs, sponge cake, shortcrust pastry. Stainless steel frame - stainless steel AISI 304 bowl and arms - transparent PET bowl lid with hole for adding ingredients during processing - speed regulator from 1 to 5 - digital timer - removable stainless steel arms for effective cleaning with bayonet fitting.
- FR** Machine pour différents types de pâtes telles que pizza, pain, biscuits, croissants, brioches, choux à la crème, génoise, pâte Brisée. Corps en acier Inox - cuve et bras en acier Inox AISI 304 - couvercle de la cuve en PET transparent avec trou pour ajouter les ingrédients pendant le travail - régulateur de vitesse de 1 à 5 - minuterie digitale - bras en acier Inox amovibles pour un nettoyage efficace avec joint à baïonnette.
- DE** Maschine für verschiedene Teigsorten wie Pizza, Brot, Kekse, Croissants, Brioches, Windbeutel, Biskuit, Mürbeteig. Gehäuse aus Edelstahl - Schüssel und Arme aus Edelstahl AISI 304 - transparenter PET-Schüsseldeckel mit Öffnung für die Zugabe von Zutaten während der Verarbeitung - Geschwindigkeitsregler von 1 bis 5 - digitaler Timer - abnehmbare Arme aus Edelstahl für eine effektive Reinigung mit Bajonettverschluss.
- ES** Máquina para diferentes tipos de masa, como pizza, pan, galletas, croissants, brioches, petisúes, bizcocho. Estructura de acero inoxidable - cubeta y brazos de acero inoxidable AISI 304 - tapa de la cubeta de PET transparente con orificio para añadir ingredientes durante el procesamiento - regulador de velocidad de 1 a 5 - temporizador digital - brazos de acero inoxidable extraíbles para una limpieza eficaz con encaje de bayoneta.
- RU** Машина для различных видов теста, таких как пицца, хлеб, печенье, круассаны, бриоши, кремовые слойки, бисквиты, коржи. Конструкция из нержавеющей стали - чаша и ручки из нержавеющей стали AISI 304 - прозрачная крышка чаши из ПЭТ с отверстием для добавления ингредиентов во время обработки - регулятор скорости от 1 до 5 - цифровой таймер - съемные ручки из нержавеющей стали для эффективной очистки с байонетным соединением.

	<b>RMS20</b>
	0,6 kW
 1 Ph	230V/1N/50 Hz
 RPM	28 - 42 - 56 - 70 rpm
	Digitale - Digital - Цифровой 0÷99'
 Kg	1÷3 Kg
 L	17 L - ø 370 mm
 mm	550 x 380 x 565(h) mm
	
 NET Kg	48 Kg
 GROSS Kg	58 Kg
 mm	595 x 500 x 735(h) mm
 m³	0,220 m³

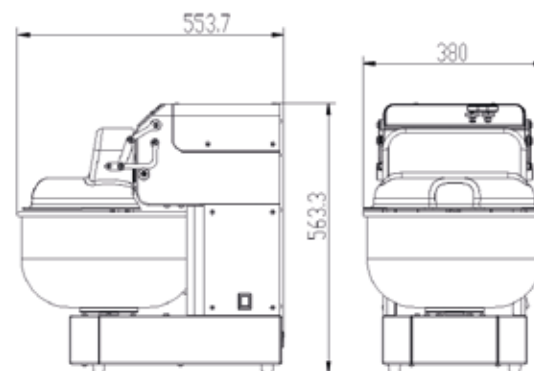

SLB5  
SLB7



SLB5



SLB7

# Impastatrici planetarie

PLANETARY MIXER  
MÉLANGEUR PLANÉTAIRE  
PLANETENMISCHER  
AMASADORA PLANETARIA  
ПЛАНЕТАРНЫЙ ТЕСТОМЕС

IT Macchina per diversi tipi di impasto quali pizza, pane, biscotti, croissant, brioches, bigné, pan di spagna, pasta frolla, meringhe, puree, salse varie, panna montata. Struttura in acciaio inox satinato - 1 vasca da 5 L per la SLB5 e da 7 L per la SLB7 - 3 utensili in dotazione, uncino, spatola e frusta tutti in acciaio inox - regolatore di velocità. Accessori: Vasca supplementare.

EN Machine for different types of dough such as pizza, bread, biscuits, croissants, brioches, cream puffs, sponge cake, shortcrust pastry, meringues, purees, various sauces, whipped cream, etc. Satin stainless steel casing - 1 x 5-litre bowl for the SLB5 and 1 x 7-litre bowl for the SLB7 - 3 tools supplied: hook, spatula and whisk all made of stainless steel -speed regulator. Accessories: additional basin.

FR Machine pour différents types de pâte tels que pizza, pain, biscuits, croissants, brioches, pains à la crème, gâteau éponge, pâte brisée, meringues, purées, sauces, crème fouettée, etc. Corps en acier inox satiné -1 cuve de 5 litres pour le SLB5 et 1 cuve de 7 litres pour le SLB7 - 3 outils fournis: crochet, spatule et fouet en acier inox - régulateur de vitesse. Accessoires: cuve supplémentaire.

DE Maschine für verschiedene Teigarten wie Pizza, Brot, Kekse, Croissants, Hörnchen, Beignets, Biskuitkuchen, Mürbeteig, Meringuen, Pürees, verschiedene Soßen, Schlagsahne, usw... Gehäuse aus satiniertem Edelstahl -1x5 L Schüssel für SLB5 und 7 L für SLB7 - 3 mitgelieferte Zubehörteile aus Edelstahl: Knethaken, Spachtel und Schneebesen - Geschwindigkeitsregler. Zubehör: Zusatzschüssel.

ES Máquina para varios tipos de masas, como pizza, pan, galletas, croissants, brioches, petisúes, bizcocho, merengues, pureas, varias salsas, nata montada, etc. Estructura de acero inoxidable satinado - 1 cuba de 5 L para la SLB5 y de 7 L para la SLB7 - 3 utensilios incluidos, gancho, espatula y batidor todos de acero inoxidable - regulador de velocidad. Accesorios: cuba adicional.

RU Машина для приготовления различных видов теста, например, для пиццы, хлеба, печенья, круассанов, бисквита, песочного теста, безе, пюре, различных соусов, взбитых сливок и т.д. Корпус из матовой нержавеющей стали -1x5 L Чаша для SLB5 и 7 L для SLB7 - 3 принадлежностей из нержавеющей стали: тестовый крючок, лопатка и виск - регулятор скорости. Аксессуары: дополнительная дежа для теста.

	SLB5	SLB7
		
	0,5 kW	
	230V/1N/50-60 Hz	
	0÷302 rpm	
	5 L	7 L
	380 x 240 x 350/500(h) mm	380 x 240 x 400/550(h) mm
		
	13 Kg	15 Kg
	14 Kg	17 Kg
	450 x 330 x 460(h) mm	450 x 330 x 490(h) mm
	0,069 m³	0,075 m³

	ELACB5VA	ELACB7VA
	Vasca - Bowl - Cuve - Wanne - Depósito - Чаша объемом	
	5 L	7 L

BH5  
BH7



# Impastatrici planetarie

PLANETARY MIXER  
MÉLANGEUR PLANÉTAIRE  
PLANETENMISCHER  
AMASADORA PLANETARIA  
ПЛАНЕТАРНЫЙ ТЕСТОМЕС

IT Macchine per diversi tipi di impasto quali pizza, pane, biscotti, croissant, brioches, bignè, pan di spagna, pasta frolla, meringhe, puree, salse varie, panna montata. Struttura verniciata bianca - 1 vasca da 4,7 L per la BH5 e da 7 L per la BH7 - 3 utensili in dotazione, uncino, spatola e frusta tutti in acciaio inox - regolatore di velocità. Accessori: Vasca supplementare.











EN Machine for different types of dough such as pizza, bread, biscuits, croissants, brioches, cream puffs, sponge cake, shortcrust pastry, meringues, purees, mayonnaise, various sauces, whipped cream, etc. White coated casing - 1 4,7 lt bowl on BH5 and 7 lt bowl on BH7 - equipped with 3 tools, hook, beater and whisk in stainless steel - speed regulator. Accessories: Additional bowl.

FR Machine pour différents types de pâte tels que pizza, pain, biscuits, croissants, brioches, pains à la crème, gâteau éponge, pâte Brisée, meringues, purées, sauces, crème fouettée. Structure peinte en blanc - 1 cuve de 4,7 L pour le BH5 e de 7 L pour le BH7- 3 outils fournis, crochet, spatule et fouet tous en inox - régulateur de vitesse. Accessoires: Cuve supplémentaire.

DE Maschine für verschiedene Teigarten wie Pizza, Brot, Kekse, Croissants, Hörnchen, Beignets, Biskuitkuchen, Mürbeteig, Meringues, Pürees, verschiedene Soßen, Schlagsahne. Weiß lackiertes Gehäuse - 5-L Schüssel für BH5 und 7-L Schüssel für BH7- 3 Werkzeuge im Lieferumfang: Haken, Spachtel und Schneebesen alle aus Edelstahl - Geschwindigkeitsregler. Zubehör: Zusätzlichen Schüssel.

ES Máquina para varios tipos de masas, como pizza, pan, galletas, croissants, brioches, petisúes, bizcocho, merengues, pureas, varias salsas, nata montada. Estructura pintada de blanco - 1 cuba de 5 L por BH5 y de 7 l por BH7- 3 utensilios incluidos, gancho, espatula y batidor todos de acero inoxidable - regulador de velocidad. Accesorios: Cuba adicional.

RU Машина для приготовления различных видов теста, например, для пиццы, хлеба, печенья, круассанов, бисквита, песочного теста, безе, пюре, различных соусов, взбитых сливок. Белая окрашенная конструкция. 1x4,7 л Чаша для BH5 и 1x7 л Чаша для BH7 - 3 принадлежностей из нержавеющей стали: тестовый крючок, лопатка и виск - регулятор скорости. Аксессуары: дополнительная дежа для теста.

	BH5	BH7
	0,3 kW	
	230V/1N/50 Hz	
	45÷270 rpm	
	4,7 L	7 L
	351 x 231 x 412(h) mm	427 x 250 x 422(h) mm
		
	14,5 Kg	17 Kg
	15,5 Kg	18 Kg
	440 x 330 x 490(h) mm	490 x 320 x 520(h) mm
	0,0711 m³	0,0824 m³

	ELACBH5VA	ELACBH7VA
	Vasca - Bowl - Cuve - Wanne - Depósito - Чаша объемом	
	5 L	7 L

BH10-BH20-BH30  
BH40-BH60  
B10K-B20K-B30K  
B40K-B60I

New



BH10



B10K



BH40



B40K

Planetarie 3 velocità

3-SPEED PLANETARY MIXER  
MÉLANGEUR PLANÉTAIRE À 3 VITESSES  
3-GANG-PLANETENMISCHER  
AMASADORA PLANETARIA 3 VELOCIDADES  
3-СКОРОСТНОЙ ПЛАНЕТАРНЫЙ ТЕСТОМЕС

IT Macchine per diversi tipi di impasto, quali pizza, pane, biscotti, croissant, brioche, bignè, pan di Spagna, pasta frolla, meringhe, puree, maionese, salse varie, panna montata, ecc.  
Struttura rivestita con vernice antigraffio - microinterruttore su coperchio e vasca - vasca estraibile - innesto rapido utensili - cambio meccanico a 3 velocità.  
I modelli B10K- B20K - BH10 - BH20 sono da banco.  
Serie BK: Vasca, frusta, spirale, spatola e coperchio grigliato in acciaio inox AISI 304 - trasmissione ad ingranaggi su tutti i modelli - salvamotore (escluso il modello B10K) - copertura testa in metallo verniciato.  
Serie BH: Frusta in acciaio inox AISI 304 - vasca, spirale, spatola e coperchio grigliato in acciaio inox AISI 201 - trasmissione ad ingranaggi per i modelli BH10, BH20, BH30 - trasmissione a cinghia per i modelli BH40 - BH60 - copertura testa in plastica verniciata.

FR Machine pour différents types de pâte tels que pizza, pain, biscuits, croissants, brioches, pains à la crème, gâteau éponge, pâte Brisée, meringues, purées, sauces, crème fouettée, etc.  
Corps recouvert de peinture anti-rayures - microinterrupteur sur couvercle et cuve - cuve amovible - dégagement rapide des outils - boîte de vitesses mécanique à 3 rapports.  
Les modèles B10K - B20K - BH10 - BH20 sont des modèles à comptoir.  
Série BK : spirale, fouet, spatule et couvercle grillé en acier inox AISI 304 - transmission par engrenages pour tous les modèles - protection du moteur (sauf pour les modèles B10K) - couvre-tête en métal laqué.  
Série BH: fouet en acier inox AISI 304 - cuve, spirale, spatule et couvercle grillé en acier inox AISI 201 - transmission par engrenages pour les modèles BH10, BH20, BH30 - transmission par courroie pour les modèles BH40-BH60 - couvre-tête en plastique laqué.

ES Máquina para varios tipos de masas, como pizza, pan, galletas, croissants, brioches, petisúes, bizcocho, merengues, pureas, varias salsas, nata montada, etc.  
Estructura recubierta con pintura anti-arañazos - microinterruptor en la protección del bol y en el bol - bol extraíble - enganche rápido de utensilios - cambio mecánico de 3 velocidades.  
Los modelos B10K - B20K - BH10 - BH20 son de banco.  
Serie BK: bol, batidor, espiral, espátula y tapa de rejilla de acero inoxidable AISI 304 - transmisión por engranajes en todos los modelos - protector del motor (excepto el modelo B10K) - revestimiento cabezal en metal pintado.  
Serie BH: batidor de acero inoxidable AISI 304 - bol, espiral, espátula y tapa de rejilla de acero inoxidable AISI 201 - transmisión por engranaje para los modelos BH10, BH20, BH30 - transmisión por correa para los modelos BH40 - BH60 - revestimiento cabezal en plástico pintado.

EN Machine for different types of dough such as pizza, bread, biscuits, croissants, brioches, cream puffs, sponge cake, shortcrust pastry, meringues, purees, various sauces, whipped cream, etc..  
Frame coated with scratch-proof paint - microswitch on bowl and lid - removable bowl - quick tool connection - 3-speed mechanical gearbox.  
The B10K - B20K - BH10 - BH20 models are table-top models.  
BK series: bowl, whip and bowl protector in stainless steel AISI 304 - gear transmission on all models - motor protection (except for model B10K) - coated metal head cover.  
BH series: whip in stainless steel AISI 304 - bowl, spiral, spatula and gridded lid in stainless steel AISI 201 - gear transmission for models BH10, BH20, BH30 - belt transmission for models BH40 and BH60 - coated plastic head cover.



DE Maschine für verschiedene Teigarten wie Pizza, Brot, Kekse, Croissants, Hörnchen, Beignets, Biskuitkuchen, Mürbeteig, Meringues, Pürees, verschiedene Soßen, Schlagsahne, usw...  
Gehäuse mit kratzfester Lackierung - Mikroschalter an Deckel und Schüssel - ausziehbare Teigschüssel - Werkzeugschnellkupplung - 3-Gang-Schaltgetriebe.  
Die Modelle B10K - B20K - BH10 - BH20 sind Tischmodelle.  
BK Serie: Schüssel, Schneebesen, Spirale, Spatel und Gitterdeckel aus Edelstahl AISI 304 - Zahnradantrieb bei allen Modellen - Motorschutz (außer beim Modell B10K) - lackierter Metallkopfdeckel.  
BH Serie: Schneebesen aus Edelstahl AISI 304 - Schüssel, Spirale, Spatel und Gitterdeckel aus Edelstahl AISI 201 - Zahnradantrieb bei den Modellen BH10, BH20, BH30 - Riemenantrieb bei den Modellen BH40-BH60 - lackierter Kunststoffkopfdeckel.

RU Машина для приготовления различных видов теста, например, для пиццы, хлеба, печенья, круассанов, бисквита, песочного теста, безе, пюре, различных соусов, взбитых сливок и т.д .  
Корпус покрыт устойчивой к царапинам краской - микровыключатель на защите чаши и дежи для теста - извлекаемая дежа для теста - быстроразъемная муфта - 3-ступенчатая механическая коробка.  
Модели B10K - B20K - BH10 - BH20 являются настольными.  
Серия BK: теста, мешалка, спирали, лопатка и решетчатая крышка из нержавеющей стали AISI 304 - зубчатая передача на всех моделях - защитный механизм двигателя (кроме модели B10K) - крышка головки из окрашенного металла.  
Серия BH: мешалка из нержавеющей стали AISI 304 - теста, спирали, лопатка и решетчатая крышка из нержавеющей стали AISI 201 - шестеренчатая передача для моделей BH10, BH20, BH30 - ременная передача для моделей BH40 - BH60 - крышка головки из окрашенного пластика.

DISPONIBILE DA  
AVAILABLE FROM 01/2026  
(MOD. BH)













OPTIONAL



	BH10	BH20	BH30	BH40	BH60
	0,45 kW (0,6 HP)	0,75 kW (1 HP)	1,1 kW (1,5 HP)	1,5 kW (2 HP)	2 kW (2,5 HP)
	-			400V/3N/50Hz	
	230V/1N/50Hz			-	
	113 - 184 - 341 rpm	108 - 161 - 382 rpm		80 - 160 - 310 rpm	87 - 195 - 297 rpm
	no	0-60'			
	10 L	20 L	30 L	40 L	60 L
	465 x 413 x 610(h) mm	523 x 483 x 780(h) mm	549 x 483 x 855(h) mm	652 x 730 x 1017(h) mm	775 x 631 x 1255(h) mm
					
	53 Kg	71 Kg	78 Kg	130 Kg	205 Kg
	65 Kg	87 Kg	93 Kg	158 Kg	234 Kg
	540 x 480 x 770(h) mm	565 x 630 x 915(h) mm	560 x 630 x 970(h) mm	645 x 730 x 1225(h) mm	710 x 850 x 1440(h) mm
	0,199 m³	0,325 m³	0,342 m³	0,576 m³	0,869 m³

DISPONIBILE DA  
AVAILABLE FROM 01/2026  
(MOD. BH)

ELACB60KCAR			
Carrello estrazione vasca - Bowl extractor trolley - Chariot extracteur de cuve - Schlüsselabzugswagen - Carro de extracción bol - Тележка для вытяжки дежа (Mod. B60I - BH60)			
	420 x 420 x 1020(h) mm		
	12,2 Kg		13,6 Kg
	640 x 430 x 610(h) mm		0,168 m³

	B10K	B20K	B30K	B40K	B60I
	0,45 kW (0,6 HP)	1,1 kW (1,5 HP)		2,2 kW (2,95 HP)	2 kW (2,5 HP)
	-	400V/3N/50Hz			
	230V/1N/50Hz		-		
	113 - 184 - 341 rpm	108 - 161 - 382 rpm		84 - 151 - 270 rpm	87 - 195 - 297 rpm
	no	0-60'			
	10 L	20 L	30 L	40 L	60 L
	452 x 432 x 606(h) mm	558 x 587 x 780(h) mm	546 x 533 x 862(h) mm	647 x 541 x 1004(h) mm	775 x 631 x 1255(h) mm
					
	55 Kg	81 Kg	85 Kg	149 Kg	207 Kg
	66 Kg	97 Kg	103 Kg	176 Kg	237 Kg
	540 x 480 x 790(h) mm	560 x 630 x 940(h) mm	560 x 630 x 1000(h) mm	640 x 730 x 1170(h) mm	710 x 845 x 1415(h) mm
	0,204 m³	0,342 m³	0,352 m³	0,5466 m³	0,843 m³

Mod.	Vasca - Bowl - Cuve Teigschüssel - Bol - Ёмкост	Uncino - Hook - Crochet Haken - Gancho - Крю	Frusta - Whisk - Fouet Rühreinsatz - Batidor - Венчик	Spatola - Spatula - Spatule Schaber - Espátula - Лопатка
B10K - BH10	<b>ACB10KBL</b>	<b>ACB10KHK</b>	<b>ACB10KWP</b>	<b>ACB10KBR</b>
B20K - BH20	<b>ACB20KBL</b>	<b>ACB20KHK</b>	<b>ACB20KWP</b>	<b>ACB20KBR</b>
B30K - BH30	<b>ACB30KBL</b>	<b>ACB30KHK</b>	<b>ACB30KWP</b>	<b>ACB30KBR</b>
B40K - BH40	<b>ACB40KBL</b>	<b>ACB40KHK</b>	<b>ACB40KWP</b>	<b>ACB40KBR</b>
B60I - BH60	<b>ACB60IBL</b>	<b>ACB60IHK</b>	<b>ACB60IWP</b>	<b>ACB60IBR</b>

K55  
K7P



K55



K7P

**KitchenAid®**

**ORIGINAL BRAND**

Impastatrici planetarie  
kitchenaid

PLANETARY MIXER  
MÉLANGEUR PLANÉTAIRE  
PLANETENMISCHER  
AMASADORA PLANETARIA  
ПЛАНЕТАРНЫЙ ТЕСТОМЕС

IT K55: Struttura rivestita con vernice antigraffio bianca - 1 vasca in acciaio inox da 5,2 L con maniglia - numero 3 utensili in dotazione, uncino, spatola e frusta a 6 fili di metallo - variatore elettronico da 0 a 10 velocità - funzione soft/start per una delicata accelerazione - spegnimento automatico in caso di calore elevato - lunghezza del cavo 109 cm - avvolgicavo presente.

K7P: Struttura rivestita con vernice antigraffio bianca - 1 vasca inox da 6,9 L - 3 utensili in dotazione, uncino, spatola e frusta lavabili in lavastoviglie - 1 presa di forza per accessori - griglia di protezione vasca - pulsante arresto di emergenza - variatore elettronico da 40 a 200 rpm (da 0 a 10).

FR K55: Corps recouvert de peinture blanche anti-rayures - 1 cuve inox de 5,2 litres avec poignée - 3 outils de série: crochet, spatule et fouet avec 6 fils métalliques - variateur électronique de 0 à 10 vitesses - fonction soft/start pour une accélération douce - arrêt automatique en cas de forte chaleur - longueur du câble 109 cm - enrouleur de câble présent.

K7P: Corps recouvert de peinture blanche anti-rayures - 1 cuve inox de 6,9 litres - 3 outils de série: crochet, spatule et fouet - 1 serrage pour accessoires - grille de protection cuve - interrupteur d'arrêt d'urgence - variateur électronique de vitesse de 40 à 200 tr/min (0 à 10).

ES K55: Estructura recubierta con pintura anti-arañazos blanca - 1 bol de acero inoxidable de 5,2 litros con asa - 3 utensilios en la dotación, gancho, espátula y batidor con 6 alambres de metal - variador electrónico de 0 a 10 velocidades - Función encendido suave para una aceleración suave - Apagado automático en caso de mucho calor - longitud del cable 109 cm - carrete de cable presente.

K7P: recubierta con pintura anti-arañazos blanca - 1 bol inoxidable de 6,9 L - 3 utensilios en la dotación, gancho, espátula, batidor que se puede limpiar en lavavajillas - 1 toma de fuerza para los accesorios - red de protección del bol - botón de parada de emergencia - variador electrónico de 40 a 200 rpm (de 0 a 10).

EN K55: Structure coated with white scratch-proof paint - 5,2 lt. stainless steel bowl with handle - equipped with 3 tools: hook, spatula and six metal wires whip - 0 to 10 speeds electronic gearbox - soft-start function for gentle acceleration - high heat automatic shutdown - 109 cm long cable - cable reel.

K7P: Structure coated with white scratch-proof paint - 6.9 litre stainless steel bowl - delivered with 3 tools: hook, spatula and whip dishwasher safe - 1 universal accessories connection - bowl protection grid - emergency stop button - electronic gearbox from 40 to 200 rpm (0 to 10).

DE K55: Gehäuse mit weißer kratzfester Lackierung überzogen. 1 Edelstahlschüssel mit 5,2 L Kapazität mit Griff - 3 beiliegende Werkzeuge: Haken, Spatel und Rührersatz mit 6 Drähten - elektronischer Geschwindigkeitsregler von 0 bis 10 Geschwindigkeiten - Soft-Start-Funktion für sanftes Anfahren - Abschaltautomatik bei großer Hitze - Kabellänge 109 cm - inklusive Kabelaufwicklung.

K7P: Gehäuse mit weißer kratzfester Lackierung überzogen. 1 Edelstahlschüssel mit 6,9 L Kapazität - 3 beiliegende Werkzeuge, Haken, Spachtel und Rührersatz - 1 Außenantrieb für Zubehörteile Schutzgitter - Notaus Schalter - elektronischer Frequenzumrichter von 40 bis 200 U/min (0 bis 10).

RU K55: Корпус покрыт белой устойчивой к царапинам краской - 1 дежа из нержавеющей стали объемом 5,2 л с ручкой - 3 прилагаемых инструмента, крючок, лопатка и венчик с 6 проводов - электронный вариатор скорости от 0 до 10 скоростей - функция плавного/мягкого старта для мягкого ускорения - автоматическое отключение при сильном нагреве - длина кабеля 109 см - устройство для намотки шнура в комплекте.





K7P: Корпус покрыт белой устойчивой к царапинам краской. 1 дежа из нержавеющей стали объемом 4,83 л. 3 прилагаемых инструмента, крючок, лопатка и мешалка - 1 внешний привод для принадлежностей Защитная решетка - аварийный выключатель - электронный преобразователь частоты от 40 до 200 об / мин (от 0 до 10).



	K55	K7P
	0,375 kW	0,325 kW
 1 Ph	230V/1N/50-60Hz	
 RPM	230 rpm	40 ÷ 200 rpm
	5,2 L	6,9 L
 mm	290 x 372 x 420(h) mm	340 x 370 x 420(h) mm
		
 NET Kg	12,7 Kg	13 Kg
 GROSS Kg	14 Kg	14,8 Kg
 mm	444 x 340 x 500(h) mm	430 x 340 x 490(h) mm
 m <sup>3</sup>	0,075 m <sup>3</sup>	0,071 m <sup>3</sup>

# Optional

ACCESSORIES  
ACCESSOIRES  
ZUBEHÖR  
ACCESORIOS  
AKCECCYAPЫ

Mod. K55	ACK55AWW	ACK55ADH	ACK55AB	ACK55ASB
	Frusta - Whisk - Fouet Rühreinsatz - Batidor - Венчик	Uncino - Hook - Crochet Haken - Gancho - Крюк	Spatola - Beater - Spatule Schaber - Espátula - Лопатка	Vasca - Bowl - Cuve Teigschüssel - Cuba - Ёмкость
				

Mod. K7P	AIK7EW	AIK7SDH	AIK7SFB	AIK7SB
				

Mod. K55-K7P	ACKPRA	ACFGA
	Sfogliatrice + 2 tagliafoglia 1,5 - 6,5 mm - Pasta roller with 2 pasta cutters 1,5 - 6,5 mm Laminoir + 2 roulettes à pâte 1,5 - 6,5 mm - Einheit zum Ausrollen von Teig + 2 Teigschneider 1,5 - 6,5 mm Amasadora de pasta + 2 cortadoras de pasta de 1,5 - 6,5 mm Машинка для раскатки теста + 2 прибора для нарезки тонких слоёв теста	Tritacarne - Grinder - Hache-viande Fleischwolf - Picadora de carne - Мясорубка
		

P25EG01  
P35EG02  
P50EG03  
P50EG03M



P35EG02













P50EG03M

# Piastre di cottura in ghisa

CAST IRON COOKING GRILLS  
PLAQUES DE CUISSON EN FONTE  
KOCPLATTEN AUS GUSSEISEN  
PLACA DE COCINA DE FUNDICIÓN  
ЧУГУННЫЕ ВАРОЧНЫЕ ПАНЕЛИ

- IT** Macchina per cuocere e riscaldare carne, pesce, verdure, toast farciti, panini, ecc. Struttura in acciaio inox - piastra di cottura in ghisa - piastra superiore auto-bilanciata - piastre singole rigate - piastre doppie rigate (P50EG03) o miste (P50EG03M).
- EN** Meat, fish, vegetable, toast, sandwich, etc. heating and cooking appliance. Stainless steel casing - cast iron cooking grill - self-balanced upper plate - single plates rilled, double plates rilled (P50EG03) o mixed (P50EG03M).
- FR** Machine à cuire et à réchauffer la viande, le poisson, les légumes, les toasts farcis, les sandwiches, etc. Corps en acier inox - plaque de cuisson en fonte - plaque supérieure autocalibrée - plaques individuelles rainurées, plaques double rainurées (P50EG03) ou mixtes (P50EG03M).
- DE** Maschine zum Kochen und Erwärmen von Fleisch, Fisch, Gemüse, gefülltem Toast, Sandwiches, etc. Edelstahlstruktur - Kochplatte aus Gusseisen - selbstausgleichende Oberplatte - Einzelplatte glatt - Doppelplatte gerillt (P50EG03) oder kombiniert (P50EG03M).
- ES** Máquina para cocinar o calentar carne, pescado, verduras, tostadas, bocadillos, etc. Estructura de acero inoxidable - placa para la cocción de fundición - placa superior auto-equilibrada - placas individuales rayadas - placas dobles rayadas (P50EG03) o mixtas (P50EG03M).
- RU** Мясо, рыба, овощи, тосты, бутерброды и т.д., приборы для отопления и приготовления пищи. Корпус из нержавеющей стали - чугунный гриль - самосбалансирующаяся верхняя панель - одинарные, двойные жареные (P50EG03) или смешанные (P50EG03M) пластины.

	<b>P25EG01</b>	<b>P35EG02</b>	<b>P50EG03 P50EG03M</b>
	1,8 kW	2,2 kW	3,6 kW
 1 Ph	230V/1N/50-60Hz		
	50÷300°C		
 mm	240 x 230 mm	340 x 230 mm	475 x 230 mm
 mm	300 x 340 x 210/500(h) mm	410 x 305 x 210/500(h) mm	570 x 305 x 210/500(h) mm
			
 NET Kg	12,5 Kg	19 Kg	25 Kg
 GROSS Kg	14 Kg	21 Kg	32 Kg
 mm	360 x 460 x 280(h) mm	480 x 460 x 280(h) mm	630 x 460 x 410(h) mm
 m <sup>3</sup>	0,047 m <sup>3</sup>	0,062 m <sup>3</sup>	0,115 m <sup>3</sup>



P50EG03



P25EG01

PFD27N  
PFD35N  
E500A  
BT700D3

New



BT700D3













PFD27N

DISPONIBILE DA  
AVAILABLE FROM 01/2026

Piastre  
ad induzione

INDUCTION PLATES  
PLAQUES A INDUCTION  
INDUKTIONSPLATTEN  
PLACAS DE INDUCCION  
ИНДУКЦИОННЫЕ ПЛИТЫ

- IT** Macchina con sistema di cottura ad induzione di calore dalla piastra al contenitore (di tipo metallico). Struttura in acciaio inox - piastra in vetroceramica - funzionamento in modalità livelli di potenza e/o in modalità temperatura - timer digitale - touch control.
- EN** Machine with heat induction cooking system from the plate to the container (of metal). Stainless steel casing - glass-ceramic cooking plate - operation in power level and/or temperature mode - digital timer - touch control.
- FR** Machine avec système de cuisson par induction de la plaque au récipient (type métal). Corps en acier inox - plaque de cuisson en vitrocéramique - fonctionnement en mode puissance et/ou température - minuterie numérique - commande tactile.
- DE** Maschine mit Wärmeinduktionskochsystem von der Platte bis zum Behälter (Metallausführung). Gehäuse aus Edelstahl - Glaskeramikplatte - Leistungsstufen- und/oder Temperaturbetrieb - digitaler Timer - Touch-Bedienung.
- ES** Máquina con sistema de cocción a través de inducción de calor de la placa al recipiente (de metal). Estructura de acero inoxidable - placa de vitrocerámica - funcionamiento con el modo nivel de potencia o con el modo temperatura - temporizador digital.
- RU** Машина с индукционной системой нагрева от плиты до емкости (из металла). Корпус из нержавеющей стали - стеклокерамическая пластина - работа в режиме уровня мощности или в температурном режиме - цифровой таймер.

	<b>PFD27N</b>	<b>PFD35N</b>	<b>E500A</b>	<b>BT700D3</b>
	2,7 kW	3,5 kW	5 kW	3,5 + 3,5 kW
	-		230-400V 3N/50Hz	-
	230V/1N/50Hz		-	230V/1N/50Hz
	ø 140 ÷ ø 220 mm		ø 218 mm	2x ø 200 ÷ ø 220 mm
	325 x 370 x 105(h) mm	343 x 440 x 120(h) mm	400 x 515 x 170(h) mm	390 x 713 x 123(h) mm
				
	5 Kg	8 Kg	10 Kg	14,3 Kg
	8 Kg	11 Kg	11,5 Kg	16,9 Kg
	430 x 370 x 160(h) mm	420 x 510 x 190(h) mm	472 x 600 x 223(h) mm	472 x 800 x 195(h) mm
	0,025 m³	0,041 m³	0,063 m³	0,074 m³



E500A

E200A  
E350C  
E350D



E350C



E200A

# Piastre ad induzione

INDUCTION PLATES  
PLAQUES A INDUCTION  
INDUKTIONSPLETTEN  
PLACAS DE INDUCCION  
ИНДУКЦИОННЫЕ ПЛИТЫ

IT Macchina con sistema di cottura ad induzione di calore dalla piastra al contenitore (di tipo metallico). Struttura in acciaio inox - piastra in vetroceramica - timer digitale da 180 minuti - touch control - fino a 10 livelli di temperatura.

E350C-E350D: 17 livelli di potenza.  
E200A: 8 livelli di potenza.

EN Machine with heat induction cooking system from the plate to the container (of metal). Stainless steel casing - glass-ceramic cooking plate - 180-minute digital timer - touch control - up to 10 temperature levels.

E350C-E350D: 17 power levels.  
E200A: 8 power levels.

FR Machine avec système de cuisson par induction de la plaque au récipient (type métal). Corps en acier inox - plaque de cuisson en vitrocéramique - minuterie numérique de 180 minutes - commande tactile - jusqu'à 10 niveaux de température.

E350C-E350D: 17 niveaux de puissance.  
E200A: 8 niveaux de puissance.

DE Maschine mit Wärmeinduktionskochsystem von der Platte bis zum Behälter (Metallausführung). Gehäuse aus Edelstahl - Glaskeramikplatte - Leistungsstufen- und/oder Temperaturbetrieb - 180 Minuten digitaler Timer - Touch-Bedienung, bis zu 10 Temperaturstufen.

E350C-E350D: 17 Leistungsstufen.  
E200A: 8 Leistungsstufen.

ES Máquina con sistema de cocción a través de inducción de calor de la placa al recipiente (de metal). Estructura de acero inoxidable - placa de vitrocerámica - temporizador digital 180 minutos - Control táctil: hasta 10 niveles de temperatura.

E350C-E350D: 17 niveles de potencia.  
E200A: 8 niveles de potencia.

RU Машина с индукционной системой нагрева от плиты до емкости (из металла). Корпус из нержавеющей стали - стеклокерамическая пластина - цифровой таймер на 180 минут - сенсорное управление - до 10 уровней температуры.

E350C-E350D: 17 уровней мощности.  
E200A: 8 уровней мощности.

	E200A	E350C	E350D
			
	2 kW	3,5 kW	
	230V/1N/50Hz		
	ø 120 ÷ ø 240 mm	ø 120 ÷ ø 260 mm	
	295 x 375 x 60(h) mm	340 x 420 x 85(h) mm	385 x 465 x 90(h) mm
			
	4 Kg	7 Kg	9 Kg
	5 Kg	8 Kg	11 Kg
	350 x 470 x 100(h) mm	460 x 500 x 160(h) mm	470 x 500 x 170(h) mm
	0,017 m <sup>3</sup>	0,037 m <sup>3</sup>	0,041 m <sup>3</sup>



E350D

D20N  
D350N  
BT350T2



D20N

New



D350N

Piastre  
induzione ad incasso

RECESSED INDUCTION PLATES  
PLAQUES À INDUCTION ENCASTRABLES  
EINBAU-INDUKTIONSKOCHFELDER  
PLACAS DE INDUCCIÓN INTEGRADAS  
ВСТРАИВАЕМЫЕ ВАРОЧНЫЕ ПОВЕРХНОСТИ  
НА ИНДУКЦИИ

DISPONIBILE DA  
AVAILABLE FROM 01/2026

- IT** Macchina con sistema di cottura ad induzione di calore dalla piastra al contenitore (di tipo metallico). Struttura in plastica - piastra in vitroceramica - funzionamento in modalità livelli di potenza e/o in modalità temperatura - timer digitale - touch control - predisposte per l'incasso.
- EN** Machine with heat induction cooking system from the plate to the container (of metal). Plastic casing - glass-ceramic cooking plate - operation in power level and/or temperature mode - digital timer - touch control - designed for built-in use.
- FR** Machine avec système de cuisson par induction de la plaque au récipient (type métal). Corps en plastique - plaque de cuisson en vitrocéramique - fonctionnement en mode puissance et/ou température - minuterie numérique - commande tactile - prêt à être encastré.
- DE** Maschine mit Wärmeinduktionskochsystem von der Platte bis zum Behälter (Metallausführung). Gehäuse aus Kunststoff - Glaskeramikplatte - Leistungsstufen- und/oder Temperaturbetrieb - digitaler Timer - Touch-Bedienung - zum Einbau bereit.
- ES** Máquina con sistema de cocción a través de inducción de calor de la placa al recipiente (de metal). Estructura de plástico - placa de vitrocerámica - funcionamiento con el modo nivel de potencia y/o con el modo temperatura - temporizador digital - preparado para el encastre.
- RU** Машина с индукционной системой нагрева от плиты до емкости (из металла). Корпус из пластика - стеклокерамическая пластина - работа в режиме уровня мощности или в температурном режиме - цифровой таймер - подготовленные для встраивания.



	<b>D20N</b>	<b>D350N</b>	<b>BT350T2</b>
	2 kW	3,5 kW	
 1 Ph	230V/1N/50Hz		
 mm	ø 200 ÷ ø 220 mm		
 mm	320 x 340 x 78(h) mm	320 x 340 x 98(h) mm	400 x 518 x 157(h) mm
			
 NET Kg	3,6 Kg	4,7 Kg	6,5 Kg
 GROSS Kg	5 Kg	6,5 Kg	8 Kg
 mm	430 x 505 x 160(h) mm	430 x 505 x 102(h) mm	415 x 535 x 340(h) mm
 m³	0,035 m³	0,022 m³	0,075 m³

**DISPONIBILE DA  
AVAILABLE FROM 01/2026**

**New**

PFD20  
BT310T3  
ET350G



PFD20



ET350G

# Piastre ad induzione

INDUCTION PLATES  
PLAQUES A INDUCTION  
INDUKTIONSPLETTEN  
PLACAS DE INDUCCIÓN  
ИНДУКЦИОННЫЕ ПЛИТЫ

- IT** Macchina con sistema di cottura ad induzione di calore dalla piastra al contenitore (di tipo metallico). Struttura in plastica - piastra in vetroceramica - funzionamento in modalità livelli di potenza e/o in modalità temperatura - timer digitale - touch control.
- EN** Machine with heat induction cooking system from the plate to the container (of metal). Plastic casing - glass-ceramic cooking plate - operation in power level and/or temperature mode - digital timer - touch control.
- FR** Machine avec système de cuisson par induction de la plaque au récipient (type métal). Corps en plastique - plaque de cuisson en vitrocéramique - fonctionnement en mode puissance et/ou température - minuterie numérique - commande tactile.
- DE** Maschine mit Wärmeinduktionskochsystem von der Platte bis zum Behälter (Metallausführung). Gehäuse aus Kunststoff - Glaskeramikplatte - Leistungsstufen- und/oder Temperaturbetrieb - digitaler Timer - Touch-Bedienung.
- ES** Máquina con sistema de cocción a través de inducción de calor de la placa al recipiente (de metal). Estructura de plástico - placa de vitrocerámica - funcionamiento con el modo nivel de potencia y/o con el modo temperatura - temporizador digital.
- RU** Машина с индукционной системой нагрева от плиты до емкости (из металла). Корпус из пластика - стеклокерамическая пластина - работа в режиме уровня мощности или в температурном режиме - цифровой таймер.

	PFD20	BT310T3	ET350G
			
	2 kW	1,8 kW + 1,3 kW	1,8 kW + 1,7 kW
 1 Ph	230V/1N/50Hz		
 mm	ø 118 ÷ ø 220 mm	2x ø 190 mm	2x ø 255 mm
 mm	290 x 370 x 44(h) mm	290 x 510 x 80(h) mm	610 x 370 x 56(h) mm
			
 Kg	2,3 Kg	4,5 Kg	5 Kg
 Kg	2,8 Kg	6 Kg	6 Kg
 mm	450 x 390 x 100(h) mm	340 x 580 x 120(h) mm	630 x 440 x 88(h) mm
 m <sup>3</sup>	0,018 m <sup>3</sup>	0,024 m <sup>3</sup>	0,025 m <sup>3</sup>



BT310T3

**PREDISPOSTA PER L'INCASSO  
DESIGNED FOR BUILT-IN USE**

# BT350W WOK



BT350W

## Piastra a induzione con wok

INDUCTION PLATES  
PLAQUES A INDUCTION  
INDUKTIONSPLETTEN  
PLACAS DE INDUCCION  
ИНДУКЦИОННЫЕ ПЛИТЫ

- IT** Macchina con sistema di cottura ad induzione di calore dalla piastra al contenitore (di tipo metallico) per pentola WOK (da ordinare separatamente). Struttura in acciaio inox - piastra in vetroceramica - funzionamento in modalità livelli di potenza o in modalità temperatura - timer digitale.
- EN** Machine with heat induction cooking system from the plate to the container (of metal) equipped with WOK (to be ordered separately). Stainless steel casing - glass-ceramic plate - operation in power level mode or in temperature mode - digital timer.
- FR** Machine avec système de cuisson à induction de la plaque au récipient (de type métallique) équipé de WOK (sur commande spécifique). Corps en acier inox - plaque vitrocéramique - fonctionnement en mode puissance ou en mode température - minuterie numérique.
- DE** Maschine mit Wärmeinduktionskochsystem von der Platte bis zum Behälter (Metallausführung) ausgestattet mit Wok -Topf (extra zu bestellen). Gehäuse aus Edelstahl Glaskeramikplatte - Leistungsstufen- oder Temperaturbetrieb - digitaler Timer.
- ES** Máquina con sistema de cocción a través de inducción de calor de la placa al recipiente (de metal) equipado con wok (a pedir a parte). Estructura de acero inoxidable - placa de vitrocerámica - funcionamiento con el modo nivel de potencia o con el modo temperatura - temporizador digital.
- RU** Машина с индукционной системой нагрева от плиты до емкости (из металла) с горшком вок (заказывается отдельно). Корпус из нержавеющей стали - стеклокерамическая пластина - работа в режиме уровня мощности или в температурном режиме - цифровой таймер.

	<b>BT350W</b>	<b>WOK</b>
	3,5 kW	-
 1 Ph	230V/1N/50Hz	-
 mm	ø 140 ÷ ø 220 mm	ø 360 mm
 mm	343 x 440 x 120(h) mm	-
		
 Kg	8 Kg	2,9 Kg
 Kg	11 Kg	3,5 Kg
 mm	510 x 420 x 190(h) mm	480 x 470 x 140(h) mm
 m <sup>3</sup>	0,041 m <sup>3</sup>	0,031 m <sup>3</sup>



WOK

# ESTA3 CVT1



ESTA3



CVT1

## Tostapane continuo

TOASTER  
GRILLE-PAIN CONTINU  
TOASTER IM DAUERZYKLUS  
TOSTADORA DE PAN CONTINUA  
ТОСТЕР НЕПРЕРЫВНОГО ДЕЙСТВИЯ ДЛЯ  
ПРИГОТОВЛЕНИЯ ГРЕНОК

- IT** Tostapane per tostare pane a ciclo continuo. Struttura in acciaio inox - tappeto di tostatura girevole in acciaio inox - camera di cottura con isolamento termico - regolatore velocità di scorrimento tappeto di cottura (manuale per il mod. ESTA3, elettronico per il mod. CVT1) - 3 modalità accensione resistenze - modalità risparmio energetico (solo per ESTA3) - uscita del pane tostato frontale o posteriore - tempo di cottura 90÷340".
- EN** Continuous bread conveyor. Stainless steel casing - stainless steel rotating toasting conveyor - baking chamber with thermal insulation - toasting conveyor speed regulator (manual for ESTA3 model, electronic for CVT1 model) - 3 heating element ignition modes - energy saving mode (only for ESTA3) - front or rear toast outlet - cooking time 90÷340".
- FR** Convoyeur à pain continu. Corps en acier inox - convoyeur de grillage rotatif en acier inox - chambre de cuisson avec isolation thermique - régulateur de vitesse du convoyeur de grillage (manuel pour le modèle ESTA3, électronique pour le modèle CVT1) - 3 modes d'allumage des éléments chauffants - modalité économie d'énergie (uniquement pour ESTA3) - sortie du pain grille frontale ou arrière - temps de cuisson 90÷340".
- DE** Toaster zum ununterbrochene Toasten von Brot. Gehäuse aus Edelstahl - drehbares Toastband aus Edelstahl - Backkammer mit Wärmedämmung - Toastband-Gleitgeschwindigkeitsregler (manuell für Modell ESTA3, elektronisch für Modell CVT1) - 3 Zündarten der Heizelemente - Energiesparbetrieb (nur für ESTA3) - Vorder- oder Hintertoastauslass - Kochzeit 90÷340".
- ES** Tostadora para tostar el pan en proceso continuo. Estructura de acero inoxidable - tapete giratorio de acero inoxidable para tostar - cámara de cocción revestida con material aislante - regulación velocidad deslizamiento tapete de cocción (manual en el modelo ESTA3, electrónico en el modelo CVT1) - 3 modos para activar las resistencias - modo de ahorro de energía (solo modelo ESTA3) - salida del pan tostado anterior o posterior - tiempo de cocción 90÷340".
- RU** Непрерывный транспортер хлеба. Корпус из нержавеющей стали - вращающийся тостер из нержавеющей стали - камера выпечки с термоизоляцией - регулятор скорости тостера (ручной для модели ESTA3, электронный для модели CVT1) - 3 режима зажигания нагревательных элементов - энергосберегающий режим (только для ESTA3) - передний или задний выход тостов - время приготовления 90÷340".

	ESTA3	CVT1
	2,45 kW	1,3 kW
	230V/1N/50-60Hz	
	350 mm	180 mm
	n. 120÷350	n. 50÷150
	480 x 560 x 430(h) mm	340 x 690 x 400(h) mm
		
	27 Kg	14 Kg
	29 Kg	16 Kg
	500 x 520 x 440(h) mm	480 x 380 x 400(h) mm
	0,115 m³	0,072 m³

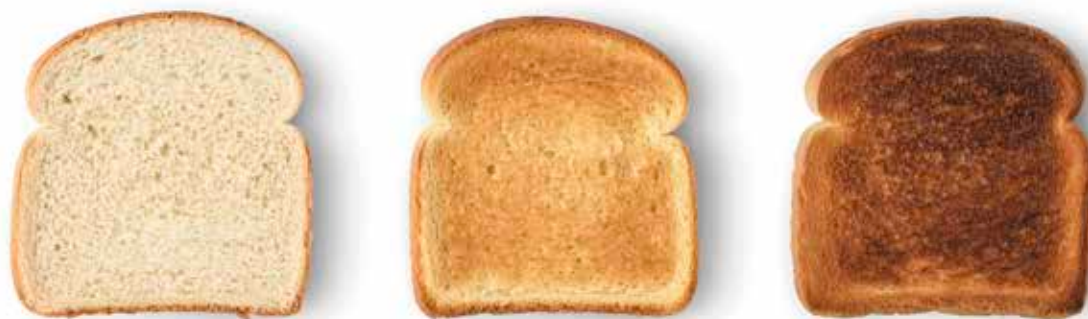

EMH450S  
EMH600S  
EMH800S



EMH600S

Salamandre

SALAMANDERS  
SALAMANDER  
SALAMANDER  
SALAMANDRAS  
ГРИЛЬ САЛАМАНДР

- IT Macchina per scaldare, gratinare e tostare. Struttura in acciaio inox - griglia cromata - termostati - regolazione posizione griglia superiore.
- EN Heating, grating and toasting machine. Stainless steel casing - chromed grill plate - thermostats - upper grill position adjustment.
- FR Machine à chauffer, griller et toaster. Corps en acier inox - plaque de grill chromée - thermostats - réglage de la position de la grille supérieure.
- DE Heiz-, Grill- und Toastgerät. Gehäuse aus Edelstahl - verchromte Grillplatte - Thermostate - Einstellung der oberen Grillposition.
- ES Máquina para calentar, gratinar y tostar. Carcasa de acero inoxidable - placa de parrilla cromada - termostatos - ajuste de la posición de la parrilla superior.
- RU Аппарат для нагрева, решетки и поджаривания. Корпус из нержавеющей стали - хромированная пластина гриля - термостаты - регулировка положения верхнего гриля.



EMH450S

	EMH450S	EMH600S	EMH800S
	2,8 kW	4 kW	5,6 kW
		-	230-400V/3N/50Hz
	230V/1N/50-60Hz		-
	0÷140 mm		
	430 x 330 mm	590 x 330 mm	790 x 330 mm
	450 x 480 x 500(h) mm	600 x 480 x 520(h) mm	800 x 480 x 500(h) mm
	37 Kg	47 Kg	57 Kg
	39 Kg	49 Kg	59 Kg
	520 x 560 x 580(h) mm	670 x 560 x 580(h) mm	870 x 560 x 580(h) mm
	0,169 m³	0,218 m³	0,282 m³

EG548  
EG5482  
EG750  
EG750M



EG750















EG750M

Fry Top  
elettrici

ELECTRIC FRY-TOPS  
FRY-TOP ÉLECTRIQUE  
ELEKTRISCHE FRY TOP  
FRY TOP ELÉCTRICOS  
ЭЛЕКТРИЧЕСКИЕ ЖАРОЧНЫЕ ПОВЕРХНОСТИ

- IT Macchina elettrica per cottura a secco o ad olio. Struttura in acciaio inox - piano di cottura in acciaio liscio o misto (liscio e rigato) - termostati di regolazione temperatura 0÷300°C - cassetto raccolta residui di cottura.
- EN Electric machine for dry or oil cooking. Stainless steel casing - cooking surface in smooth or mixed (smooth and ribbed) steel - temperature adjustment thermostats 0÷300°C - cooking residue collection drawer.
- FR Machine électrique pour la cuisson à sec ou à l'huile. Corps en acier inox - surface de cuisson en acier lisse ou mixte (lisse et nervuré) - thermostats de réglage de la température 0÷300°C - tiroir de récupération des résidus de cuisson.
- DE Gerät zum Trocken- oder Ölkochen. Struktur aus Edelstahl - Kochfläche aus glattem oder gemischtem Stahl (glatt und gerillt) - Thermostate zur Temperatureinstellung 0÷300°C - Schublade zur Sammlung von Kochrückständen.
- ES Máquina eléctrica para cocinar en seco o en aceite. Estructura de acero inoxidable - superficie de cocción de acero liso o mixto (liso y acanalado) - termostatos de regulación de la temperatura 0÷300°C - cajón de recogida de residuos de cocción.
- RU Электрическая машина для сухой или масляной варки. конструкция из нержавеющей стали - варочная поверхность из гладкой или смешанной (гладкой и ребристой) стали - термостаты регулировки температуры 0÷300°C - ящик для сбора остатков пищи.

	EG548	EG5482	EG750	EG750M
				
	3 kW		6 kW	
	-		230-400V/3N/50Hz	
	230V/1N/50-60Hz		-	
	0÷300°C			
	Liscio - Smooth Гладкий	Misto - Mixed комбинированная	Liscio - Smooth Гладкий	Misto - Mixed комбинированная
	552 x 366 mm		746 x 398 mm	
	560 x 470 x 250(h) mm		750 x 520 x 310(h) mm	
				
	25 Kg		38 Kg	
	27 Kg		41 Kg	
	615 x 535 x 300(h) mm		800 x 580 x 340(h) mm	
	0,098 m <sup>3</sup>		0,158 m <sup>3</sup>	



EG548



EG5482

WM1  
WM15  
WMFY2205



WM15



WMFY2205

waffle machine

WAFFLE MACHINE  
APPAREIL À GAUFRES  
WAFFELMASCHINEN  
GOFRERA  
МАШИНА ДЛЯ ВЫПЕКАНИЯ ВАФЕЛЬ

IT Macchina per realizzare waffle. Struttura in acciaio inox - piastra di cottura teflonata - termostato 50÷300°C - timer 0÷5 minuti.  
WMFY2205 è dotato di piastra rotante per una distribuzione dell'impasto più omogenea.

EN Waffle machine. Stainless steel casing - Teflon cooking grill - thermostat 50÷300°C - 0÷5 minute timer.  
WMFY2205 is equipped with a rotating plate for more even batter distribution.

FR Appareil pour préparer les gaufres. Corps en acier inox - plaque de cuisson en téflon - thermostat 50÷300°C - minuterie 0÷5 minutes.  
Le WMFY2205 est équipé d'un plateau rotatif pour une distribution plus homogène du mélange.

DE Maschine zur Zubereitung von Waffeln. Edelstahlgehäuse - teflonbeschichtete Kochplatte - Thermostat 50÷300°C - Timer 0÷5 Minuten.  
Die WMFY2205 ist mit einem Drehteller für eine gleichmäßigere Teigverteilung ausgestattet.

ES Máquina para preparar waffle. Estructura de acero inoxidable - placa para la cocción con teflón - termostato 50÷300°C - temporizador 0÷5 minutos.  
WMFY2205 está equipada con un plato giratorio para una distribución más uniforme del producto.

RU Вафельная машина. Корпус из нержавеющей стали - Тefлоновый гриль - термостат 50÷300°C - таймер 0÷5 минут.  
WMFY2205 оснащен вращающейся пластиной для более равномерного распределения теста.



WM1

i	WM1	WM15	WMFY2205
⚡	1 kW	1,5 kW	1,3 kW
⚡ 1 Ph	230V/1N/50-60Hz		
🌡️	50÷300°C		
🕒	0÷5'		
📏 mm	ø 185 mm	275 x 245 mm	ø 185 mm
↗️ mm	255 x 435 x 255/570(h) mm	340 x 370 x 240/580(h) mm	280 x 520 x 310/655(h) mm
🚚			
📖 NET Kg	6 Kg	11,5 Kg	9 Kg
📖 GROSS Kg	8 Kg	14,5 Kg	10 Kg
📦 mm	440 x 260 x 260(h) mm	390 x 430 x 320(h) mm	310 x 500 x 350(h) mm
📦 m³	0,029 m³	0,054 m³	0,055 m³



FYEP1  
FYEP2



FYEP1





FYEP2

New

Forni pizza elettrici

ELECTRIC PIZZA OVENS  
FOURS À PIZZA ÉLECTRIQUES  
ELEKTRISCHE PIZZAÖFEN  
HORNOS ELÉCTRICOS PARA PIZZA  
ЭЛЕКТРИЧЕСКИЕ ПЕЧИ ДЛЯ ПИЦЦЫ

- IT** Forni elettrici professionali per la cottura di pizza, focacce, ecc. Struttura in acciaio inox - piano di cottura refrattario - porte con vetro - illuminazione interna - 2 termostati per ogni camera - timer meccanico 0÷120 minuti - termostato meccanico 50÷350°C.
- EN** Professional electric ovens for baking pizza, focaccia, etc. Stainless steel casing - refractory cooking floor - glass doors - internal lighting - 2 thermostats for each chamber - mechanical timer 0÷120 minutes - mechanical thermostat 50÷350°C.
- FR** Fours électriques professionnels pour la cuisson de pizzas, focaccia, etc. Corps en acier inox - sole de cuisson réfractaire - portes vitrées - éclairage intérieur - 2 thermostats pour chaque chambre - minuterie mécanique 0÷120 minutes - thermostat mécanique 50÷350°C.
- DE** Professionelle elektrische Öfen zum Backen von Pizza, Focaccia, usw. Struktur aus Edelstahl - feuerfester Boden - Glas-Türen - Innenbeleuchtung - 2 Thermostate für jede Kammer - mechanischer Timer 0÷120 Minuten - mechanischer Thermostat 50÷350°C.
- ES** Hornos eléctricos profesionales para la cocción de pizza, focaccia, etc. Estructura de acero inoxidable - fondo de cocción refractario - puertas con cristal - iluminación interna - 2 termostatos para cada cámara - temporizador mecánico 0÷120 minutos - - termostato mecánico 50÷350°C.
- RU** Профессиональные электрические печи для выпечки пиццы, фокачки и т.д. конструкция из нержавеющей стали - огнеупорный варочный пол - дверцы со стеклом - внутреннее освещение - 2 термостата для каждой камеры - механический таймер 0÷120 минут - механический термостат 50÷350°C.

	FYEP1	FYEP2
	2 kW	3 kW
 1 Ph	230V/1N/50-60Hz	
	50÷350°C	
	Meccanico - Mechanical - механический 0÷120'	
	400 x 400 x 170(h) mm	400 x 400 x 170(h) mm x2
 mm	560 x 570 x 280(h) mm	560 x 570 x 440(h) mm
		
 NET Kg	19,8 Kg	30,7 Kg
 GROSS Kg	20,8 Kg	33,9 Kg
 mm	610 x 570 x 320(h) mm	610 x 570 x 490(h) mm
 m <sup>3</sup>	0,111 m <sup>3</sup>	0,170 m <sup>3</sup>

DISPONIBILE DA  
AVAILABLE FROM 01/2026

**New**

# NTPROSIT



NTPROSIT

Speed oven  
forno combinato

CONVECTION OVENS  
FOURS À CONVECTION  
KONVEKTIONSOFFEN  
HORNOS DE CONVECCIÓN  
КОНВЕКЦИОННЫЕ ПЕЧИ

IT Forno Speed Oven - riduzione dei tempi di cottura fino all'80% rispetto ai forni convenzionali. Camera di cottura in acciaio inox AISI 304 - forno combinato con aria calda e microonde da 1,5 kW - schermo touch screen - riscaldamento veloce - possibilità di impostare diversi cicli di cottura per ogni ricetta - modalità di impostazione cottura anche manuale - ricette preimpostate - possibilità di memorizzare fino a 1024 ricette - entrata usb - piedini regolabili in altezza 98÷125 mm. Accessori inclusi: pala - cestello rete in teflon - piastra tonda rete in teflon - teglia per pizza - piastra in teflon.

FR Four Speed Oven - temps de cuisson réduit jusqu'à 80% par rapport aux fours conventionnels. Chambre de cuisson en acier inox AISI 304 - four combiné à air chaud et micro-ondes 1,5 kW - écran tactile - chauffage rapide - possibilité de programmer différents cycles de cuisson pour chaque recette - mode de réglage de la cuisson également manuel - recettes préprogrammées - possibilité de mémoriser jusqu'à 1024 recettes - entrée usb - pieds réglables en hauteur 98÷125 mm. Accessoires inclus: pelle - panier en filet téflon - plaque ronde en filet téflon - plaque à pizza - plaque en téflon.

ES Horno Speed Oven - tiempo de cocción reducido hasta un 80% en comparación con los hornos convencionales. Cámara de cocción de acero inoxidable AISI 304 - horno combinado con aire caliente y microondas 1,5 kW - pantalla táctil - calentamiento rápido - posibilidad de programar diferentes ciclos de cocción para cada receta - modo de ajuste de la cocción también manual - recetas preestablecidas - posibilidad de almacenar hasta 1024 recetas - entrada usb - pies regulables en altura 98÷125 mm. Accesorios incluidos: pala - cesta de red de teflón - plato redondo de red de teflón - bandeja para pizza - plato de teflón.

EN Speed Oven - cooking time reduced by up to 80% compared to conventional ovens. Cooking chamber in stainless steel AISI 304 - combined oven with hot air and microwave 1.5 kW - touch screen - fast heating - possibility to set different cooking cycles for each recipe - cooking setting mode also manual - pre-set recipes - possibility to store up to 1024 recipes - usb input - height adjustable feet 98÷125 mm. Accessories included: shovel - teflon net basket - teflon net round plate - pizza pan - teflon plate.

DE Speed Oven - bis zu 80% kürzere Garzeit im Vergleich zu herkömmlichen Öfen. Garraum aus Edelstahl AISI 304 - kombinierter Ofen mit Heißluft und Mikrowelle 1,5 kW - Touchscreen - schnelles Aufheizen - Möglichkeit, verschiedene Garzyklen für jedes Rezept einzustellen - Kocheinstellungsmodus auch manuell - voreingestellte Rezepte - Möglichkeit, bis zu 1024 Rezepte zu speichern - USB-Eingang - höhenverstellbare Füße 98÷125 mm. Mitgeliefertes Zubehör: Schaufel - Korb aus Teflonnetz - runder Teller aus Teflonnetz - Pizzapfanne - Teflonplatte.

RU Скоростной духовой шкаф - время приготовления сокращается до 80% по сравнению с обычными духовками. варочная камера из нержавеющей стали AISI 304 - комбинированная печь с горячим воздухом и микроволнами 1,5 кВт - сенсорный экран - быстрый нагрев - возможность установки различных циклов приготовления для каждого рецепта - режим настройки приготовления также ручной - предустановленные рецепты - возможность сохранения до 1024 рецептов - usb-вход - регулируемые по высоте ножки 98÷125 мм. Аксессуары в комплекте: лопатка - корзина с тефлоновой сеткой - круглая тарелка с тефлоновой сеткой - сковорода для пиццы - тефлоновая тарелка.



FORNO COMBINATO  
COMBI OVEN

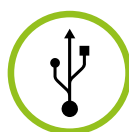

ENTRATA USB  
USB INPUT



TOUCH SCREEN



VELOCE  
FAST

	<b>NTPROSIT</b>
	3,5 kW
 1 Ph	230V/1N/50-60Hz
	Max. 280°C
	17 L
	305 x 305 x 185(h) mm
 mm	460 x 675 x 660(h) mm
	
 NET Kg	64 Kg
 GROSS Kg	84 Kg
 mm	770 x 565 x 740(h) mm
 m <sup>3</sup>	0,325 m <sup>3</sup>

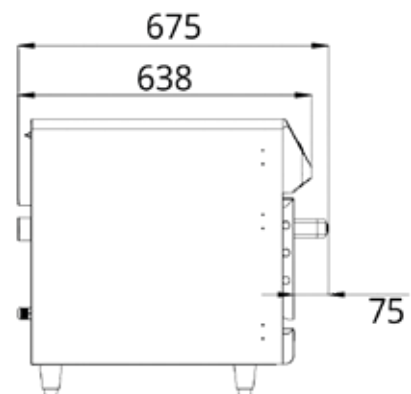
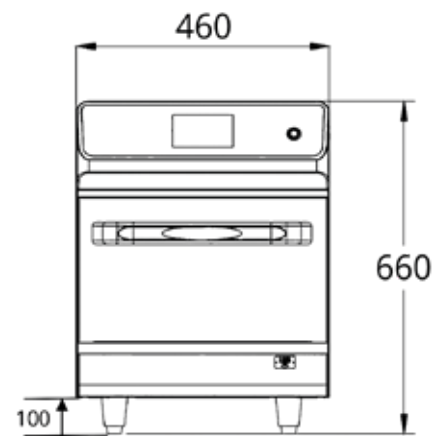

# Optional

ACCESSORIES  
ACCESSOIRES  
ZUBEHÖR  
ACCESORIOS  
AKCECCYAPЫ

(OPTIONAL INCLUSI / INCLUDED)

	ACNTPRO1	ACNTPRO2	ACNTPRO3	ACNTPRO4	ACNTPRO5
	Pala Shovel	Cestello rete Teflon Teflon mesh basket	Piastra tonda in Teflon Round Teflon mesh pad	Teglia per pizza Round Pizza Pan	Piastra in Teflon Teflon coated plate
					
	410 x 300 x 70(h) mm	280 x 210 x 25(h) mm	ø 210 mm	ø 257 mm - 20(h) mm	343 x 312 x 25(h) mm

(OPTIONAL NON INCLUSO / NOT INCLUDED)

	ACNTPRO6
	Piastra grill in alluminio - Aluminum grill plate
	
	280 x 205 x 8(h) mm

# H7530



H7530

New

## Forno a convezione

CONVECTION OVEN  
FOUR À CONVECTION  
KONVEKTIONSOFFEN  
HORNO DE CONVECCIÓN  
КОНВЕКЦИОННЫЕ ПЕЧИ

DISPONIBILE DA  
AVAILABLE FROM 01/2026

- IT** Forno a convezione ventilato con umidificatore - struttura in acciaio inox - 2 ventole - termostato meccanico 50÷250°C - timer meccanico 0÷120 minuti - porta con doppio vetro - illuminazione interna. Capienza di 4 teglie GN1/1 - 3 teglie incluse.
- EN** Convection ventilated oven with humidifier - stainless steel casing - 2 fans - mechanical thermostat 50÷250°C - mechanical timer 0÷120 minutes - double glass door - internal lighting. Capacity of 4 GN1/1 trays - 3 trays included.
- FR** Four ventilé à convection avec humidificateur - corps en acier inox - 2 ventilateurs - thermostat mécanique 50÷250°C - minuterie mécanique 0÷120 minutes - double porte en verre - éclairage intérieur. Capacité de 4 plaques GN1/1 - 3 plaques incluses.
- DE** Umluft-Backofen mit Befeuchter - Gehäuse aus Edelstahl - 2 Ventilatoren - mechanischer Thermostat 50÷250°C - mechanischer Timer 0÷120 Minuten - doppelte Glastür - Innenbeleuchtung. Kapazität von 4 GN1/1 Blechen - 3 Bleche im Lieferumfang enthalten.
- ES** Horno ventilado de convección con humidificador - estructura de acero inoxidable - 2 ventiladores - termostato mecánico 50÷250°C - temporizador mecánico 0÷120 minutos - doble puerta de cristal - iluminación interna. Capacidad para 4 bandejas GN1/1 - 3 bandejas incluidas.
- RU** Конвекционная вентилируемая печь с увлажнителем - конструкция из нержавеющей стали - 2 вентилятора - механический термостат 50÷250°C - механический таймер 0÷120 минут - двойная стеклянная дверца - внутреннее освещение. Вместимость 4 противня GN1/1 - 3 противня в комплекте.

	<b>H7530</b>
	2,9 kW
 1 Ph	230V/1N/50-60Hz
	50÷250°C
	Meccanico - Mechanical - механический 0÷120'
	65 L - 4x GN1/1 555 x 360 x 330(h) mm
	675 x 600 x 502(h) mm
	
 NET Kg	29 Kg
 GROSS Kg	32 Kg
 mm	760 x 670 x 570(h) mm
 m <sup>3</sup>	0,290 m <sup>3</sup>

FD21  
FD47  
FD66



FD66



FD21

# Forni a convezione

CONVECTION OVENS  
FOURS À CONVECTION  
KONVEKTIONSOFFEN  
HORNOS DE CONVECCIÓN  
КОНВЕКЦИОННЫЕ ПЕЧИ

- IT Forni a convezione ventilati - struttura in acciaio inox - termostato meccanico 65÷260°C, timer meccanico 0÷120 minuti - porta con doppio vetro. Griglie incluse.
- EN Ventilated convection ovens - stainless steel structure - mechanical thermostat 65÷260°C, mechanical timer 0÷120 minutes - door with double glass. Grids included.
- FR Fours à convection ventilés - structure en acier inox - thermostat mécanique 65÷260°C, minuterie mécanique 0÷120 minutes - porte avec double vitrage. Grille inclus.
- DE Umluftkonvektionsöfen - Edelstahlgehäuse - mechanischer Thermostat 65÷260°C, mechanischer Timer von 0 bis 120 Minuten - Tür mit Doppelglas. Inklusive Rost.
- ES Hornos de convección ventilados - estructura de acero inoxidable - termostato mecánico 65÷260°C, temporizador mecánico 0÷120 minutos - puerta con doble cristal. Rejilla incluidas.
- RU Вентилируемые конвекционные печи - конструкция из нержавеющей стали - механический термостат 65÷260°C, механический таймер 0÷120 минут - дверца с двойным стеклом. Решётка включены.

	FD21	FD47	FD66
			
	2,1 kW	2,5 kW	2,8 kW
 1 Ph	230V/1N/50-60Hz		
	65÷260°C		
	Meccanico - Mechanical - механический 0÷120'		
	21 L - 3x GN1/2 358 x 291 x 219(h) mm	47 L - 4x 450x330 mm 470 x 356 x 250(h) mm	66 L - 4x 450x330 mm 470 x 356 x 355(h) mm
 mm	475 x 500 x 380(h) mm	580 x 570 x 406(h) mm	580 x 570 x 510(h) mm
			
 NET Kg	15 Kg	20 Kg	24 Kg
 GROSS Kg	18 Kg	24 Kg	27 Kg
 mm	570 x 570 x 460(h) mm	660 x 650 x 465(h) mm	660 x 650 x 580(h) mm
 m <sup>3</sup>	0,149 m <sup>3</sup>	0,199 m <sup>3</sup>	0,250 m <sup>3</sup>



FD47

# P90DZH M25LZS



P90DZH

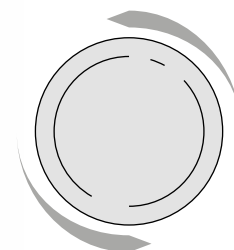

PIATTO GIREVOLE

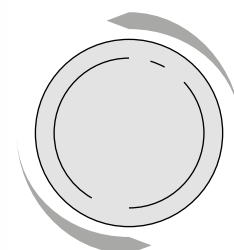

PIATTO GIREVOLE

25 L















M25LZS

# Forni microonde

MICROWAVES OVENS  
FOURS À MICRO-ONDES  
MIKROWELLEN  
HORNOS MICROONDAS  
МИКРОВОЛНОВЫЕ ПЕЧИ

- IT** P90DZH: Forno a microonde con comandi digitali e piatto girevole. Lamiera verniciata nera con porta vetro a specchio - 6 livelli di potenza - funzione defrost - timer digitale - segnale di allarme di fine cottura - controllo di sicurezza per bambini - potenza resa 0,9 kW.  
M25LZS: Forno a microonde con comandi meccanici e piatto girevole. Lamiera verniciata bianca con porta vetro - 6 livelli di potenza - funzione defrost- potenza resa 0,9 kW.
- EN** P90DZH: Microwave oven with digital controls and rotating plate. Black painted plate with mirrored glass door - 6 power levels - defrost function - digital timer - warning signal at the end of cooking - child safety control - power output 0,9 kW.  
M25LZS: Microwave oven with mechanical controls and rotating plate. White painted plate with glass door - 6 power levels - defrost function - Power output 0,9 kW.
- FR** P90DZH: Four à micro-ondes à commande numérique et plan tournant. Tôle peinte en noir avec porte réfléchissante - 6 niveaux de puissance - fonction dégivrage - minuterie numérique - alarme de fin de cuisson - contrôle de sécurité pour enfants -puissance de 0,9 kW.  
M25LZS: Four à micro-ondes avec commandes mécaniques et plan tournant. Tôle peinte en blanc avec porte vitrée - 6 niveaux de puissance - fonction dégivrage - puissance de 0,9 kW.
- DE** P90DZH: Mikrowelle mit digitaler Steuerung und drehendem Teller. Schwarz lackiertes Blech mit Spiegelglastür - 6 Leistungsstufen - Abtaufunktion - Digitaltimer - Kochende Warnsignal - Kindersicherung Innenbeleuchtung - Leistung 0,9 kW.  
M25LZS: Mikrowelle mit mechanischer Steuerung und drehendem Teller. Weiß lackiertes Blech mit Glastür - 6 Leistungsstufen - Abtaufunktion - Innenbeleuchtung - Leistung 0,9 kW.
- ES** P90DZH: Horno microondas con controles digitales y plataforma giratoria. Chapa pintada de color negro con puerta de cristal espejo - 6 niveles de potencia - función de descongelación - temporizador digital - señal de alarma de fin de cocción - control de seguridad para niños - potencia de salida 0,9 kW.  
M25LZS: Microondas con mandos mecánicos y plataforma giratoria. Chapa pintada de blanco con puerta de cristal - 6 niveles de potencia - función de descongelación - potencia de salida 0,9 kW.
- RU** P90DZH: Микроволновая печь с цифровым управлением и поворотным стол. Окрашенный в черный цвет листовой металл с зеркальной стеклянной дверцей - 6 уровней мощности - функция размораживания - цифровой таймер - сигнал тревоги в конце приготовления - контроль безопасности для детей выход мощности 0,9 кВт.-  
M25LZS: Микроволновая печь с механическим управлением и поворотным столом. Окрашенный в белый цвет листовой металл со стеклянной дверцей - 6 уровней мощности - функция размораживания - выход мощности 0,9 кВт.

	P90DZH	M25LZS
	0,9 kW	
 1 Ph	230V/1N/50Hz	
	25 L	
	Digitale - Digital - Цифровой 0÷95'	
	480 x 380 x 281(h) mm	480 x 380 x 275(h) mm
		
 NET Kg	14 Kg	15 Kg
 GROSS Kg	14,5 Kg	16 Kg
 mm	550 x 460 x 340(h) mm	
 m <sup>3</sup>	0,084 m <sup>3</sup>	
	 Ø 270 mm	 Ø 270 mm

MF914  
MC2452

25 L



MF914

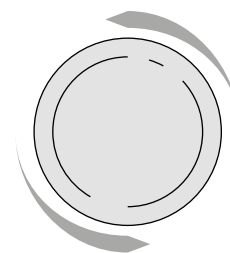

PIATTO GIREVOLE

Forni microonde

MICROWAVES OVENS  
FOURS À MICRO-ONDES  
MIKROWELLEN  
HORNOS MICROONDAS  
МИКРОВОЛНОВЫЕ ПЕЧИ

**IT** Forni microonde con camera di cottura e rivestimento esterno in acciaio inox - 1 magnetron - comandi digitali - illuminazione interna.  
 MF914: Forno a microonde con grill. 5 livelli di potenza in modalità microonde; 2 in modalità combinata; 1 in modalità grill. 8 modalità di cottura preimpostate - funzione defrost - potenza resa 0,9 kW.  
 MC2452: Forno microonde con convezione e grill.  
 Funzionamento combinato: C-1 microonde + convezione; C-2 microonde + grill; C-3 grill + convezione; C-4 microonde + convezione + grill. Potenza resa 0,9 kW microonde, 2,4 kW modalità convezione, 1,4 kW in modalità grill.

**EN** Microwave oven with stainless steel cooking chamber and external casing - 1 magnetron - digital controls - internal lighting.  
 MF914: Microwave oven with grill. 5 power levels in microwave mode; 2 in combined mode; 1 in grill mode. 8 preset cooking modes - defrost function - power output 0.9 kW.  
 MC2452: Microwave oven with convection and grill.  
 Combined operation: C-1 microwave + convection; C-2 microwave + grill; C-3 grill + convection; C-4 microwave + convection + grill. Power output 0.9 kW microwave, 2.4 kW for convection mode, 1.4 kW in grill mode.

**FR** Four à micro-ondes avec chambre de cuisson et revêtement extérieur en acier inox - 1 magnétron - commandes numériques - éclairage intérieur.  
 MF914 : Four à micro-ondes avec grill. 5 niveaux de puissance en mode micro-ondes ; 2 en mode combiné ; 1 en mode grill. 8 types de cuisson prédéfinis - fonction décongélation - puissance de 0,9 kW.  
 MC2452 : Four à micro-ondes avec convection et grill.  
 Fonctionnement combiné : C-1 micro-ondes + convection ; C-2 micro-ondes + grill ; C-3 grill + convection ; C-4 micro-ondes + convection + grill. Puissance 0,9 kW en mode micro-ondes, 2,4 kW en mode convection, 1,4 kW en mode grill.

**DE** Mikrowellenherd mit Edelstahl-Garraum und Außenverkleidung - 1 Magnetron - digitale Steuerung - Innenbeleuchtung.  
 MF914: Mikrowellenherd mit Grill. 5 Leistungsstufen im Mikrowellenmodus; 2 im Kombi-Modus; 1 im Grillmodus. 8 voreingestellte Gararten - Auftaufunktion - Leistung 0,9 kW.  
 MC2452: Mikrowellenherd mit Konvektion und Grill.  
 Kombi-Betrieb, C-1 Mikrowelle + Konvektion; C-2 Mikrowelle + Grill; C-3 Grill + Konvektion; C-4 Mikrowelle + Konvektion + Grill; Stromabgabe 0,9 kW Mikrowelle, 2,4 kW für Konvektionsmodus und schließlich 1,4 kW im Grill.

**ES** Horno microondas con cámara de cocción y revestimiento exterior de acero inoxidable - 1 magnetrón - mandos digitales - iluminación interna.  
 MF914: Horno microondas con grill. 5 niveles de potencia en modo microondas; 2 en modo combinado; 1 en modo grill. 8 modos de cocción preajustados - función de descongelación - potencia 0,9 kW.  
 MC2452: Horno microondas con convección y parrilla.  
 Funcionamiento combinado: C-1 microondas + convección; C-2 microondas + parrilla; C-3 parrilla+ convección; C-4 microondas + convección + parrilla. Potencia 0,9 kW microondas, 2,4 kW convección y 1,4 kW en parrilla.

	<b>MF914</b>	<b>MC2452</b>
	1,45 kW	2,4 kW
 1 Ph	230V/1N/50Hz	
	Digitale - Digital - Цифровой 0÷95'	
	25 L 330 x 350 x 200(h) mm	25 L 328 x 343 x 230(h) mm
	513 x 400 x 305(h) mm	510 x 466 x 305(h) mm
		
 NET Kg	16 Kg	18 Kg
 GROSS Kg	17,5 Kg	20 Kg
 mm	580 x 460 x 350(h) mm	580 x 495 x 363(h) mm
 m <sup>3</sup>	0,094 m <sup>3</sup>	0,104 m <sup>3</sup>
	 Ø 300 mm	 MULTIFUNCTION

**RU** Микроволновая печь с рабочей камерой и внешним корпусом из нержавеющей стали - 1 магнетрон - цифровое управление - внутреннее освещение.  
 MF914: Микроволновая печь с грилем. 5 уровней мощности в режиме микроволн; 2 в комбинированном режиме; 1 в режиме гриля. 8 предустановленных режимов приготовления - функция разморозки - мощность 0,9 кВт.  
 MC2452: Микроволновая печь с конвекцией и грилем.  
 Комбинированный режим: C-1 микроволны + конвекция; C-2 микроволны + гриль; C-3 гриль + конвекция; C-4 микроволны + конвекция + гриль. Мощность микроволн 0,9 кВт, режим конвекции 2,4 кВт, режим гриля 1,4 кВт.

EMA34GTQ  
EM025FJT

34 L



EMA34GTQ

25 L













EM025FJT

Forni microonde

MICROWAVES OVENS  
FOURS À MICRO-ONDES  
MIKROWELLEN  
HORNOS MICROONDAS  
МИКРОВОЛНОВЫЕ ПЕЧИ

- IT** Forni microonde professionali con comandi digitali - display a led - camera di cottura, rivestimento interno e maniglia in acciaio inox - distribuzione microonde dall'alto verso il basso - 100 programmi registrabili e 5 livelli di potenza - illuminazione interna.  
EMA34GTQ: 2 magnetron con antenne contrapposte - filtro aria removibile - potenza resa 1,8 kW.  
EM025FJT: 1 magnetron - potenza resa 1 kW.
- EN** Professional microwave oven with digital controls - LED display - cooking chamber, interior lining and handle made of stainless steel - microwave distribution from top to bottom - 100 adjustable programmes and 5 power levels - interior lighting.  
EMA34GTQ: 2 magnetrons with opposing antennas - removable air filter - power output 1.8 kW.  
EM025FJT: 1 magnetron - power output 1 kW.
- FR** Fours à micro-ondes professionnels avec commandes numériques - affichage LED - chambre de cuisson, revêtement intérieur et poignée en acier inox - distribution des micro-ondes de haut en bas - 100 programmes réglables et 5 niveaux de puissance - éclairage intérieur.  
EMA34GTQ: 2 magnétrons avec antennes opposées - filtre à air amovible - puissance de 1,8 kW.  
EM025FJT: 1 magnétron - puissance 1 kW.
- DE** Professionelle Mikrowellenherde mit digitaler Steuerung - LED-Anzeige - Garraum, Innenverkleidung und Griff aus Edelstahl - Mikrowellenverteilung von oben nach unten - 100 einstellbare Programme und 5 Leistungsstufen - Innenbeleuchtung.  
EMA34GTQ: 2 Magnetrons mit gegenüberliegenden Antennen - herausnehmbarer Luftfilter - Leistung 1,8 kW.  
EM025FJT: 1 Magnetron - Ausgangsleistung 1 kW.
- ES** Hornos microondas profesionales con mandos digitales - pantalla LED - cámara de cocción, revestimiento interior y asa de acero inoxidable - distribución de las microondas de arriba abajo - 100 programas ajustables y 5 niveles de potencia - iluminación interior.  
EMA34GTQ: 2 magnetrones con antenas opuestas - filtro de aire extraíble - potencia 1,8 kW.  
EM025FJT: 1 magnetrón - potencia 1 kW.
- RU** Профессиональные микроволновые печи с цифровым управлением - светодиодный дисплей - рабочая камера, внутренняя облицовка и ручка из нержавеющей стали - распределение микроволн сверху вниз - 100 настраиваемых программ и 5 уровней мощности - внутренняя подсветка.  
EMA34GTQ: 2 магнетрона с противоположными антеннами - съемный воздушный фильтр - мощность 1,8 кВт.  
EM025FJT: 1 магнетрона - мощность 1 кВт.

	EMA34GTQ	EM025FJT
	2,8 kW	1,55 kW
	230V/1N/50Hz	
	Digitale - Digital - Цифровой 0÷60'	
	34 L - GN2/3 360 x 409 x 225(h) mm	25 L - GN2/3 327 x 346 x 200(h) mm
	574 x 528 x 367(h) mm	510 x 440 x 310(h) mm
		
	32,2 Kg	15 Kg
	34,3 Kg	17 Kg
	641 x 559 x 451(h) mm	580 x 470 x 380(h) mm
	0,148 m³	0,104 m³

MJ6051AT  
MJ6091AT  
MJ6053AT  
MJ6093AT

26 L



MJ6051AT



MJ6053AT

**SAMSUNG**

**ORIGINAL BRAND**

**Forni microonde**  
Samsung

MICROWAVES OVENS  
FOURS À MICRO-ONDES  
MIKROWELLEN  
HORNOS MICROONDAS  
МИКРОВОЛНОВЫЕ ПЕЧИ

IT Forni a microne Samsung. Struttura e camera di cottura in acciaio inox - 2 magnetron - camera di cottura da 26 L con fondo fisso - illuminazione interna - filtro aria facilmente removibile - sovrapponibile.  
MJ6051AT - MJ6091AT: 5 livelli di potenza - comandi manuali.  
MJ6053AT - MJ6093AT: 50 programmi di cottura e funzione di self service - programmabile - funzione moltiplicatore x2 - contatore cicli lavorativi per programma - blocco tasti - funzione avviso pulizia filtro.











EN Samsung microwave ovens. Stainless steel casing and cooking chamber - 2 magnetrons - 26 L cooking chamber with fixed bottom - internal lighting - easily removable air filter - stackable.  
MJ6051AT - MJ6091AT: 5 power levels - manual controls.  
MJ6053AT - MJ6093AT: 50 cooking programs and self service function - programmable - 2x multiplying function - work cycle counter per program - key lock - filter cleaning warning function.

FR Fours à micro-ondes Samsung. Corps et chambre de cuisson en acier inox - 2 magnétrons - chambre de cuisson 26 lt. à fond fixe - éclairage interne - filtre à air facilement amovible - superposable.  
MJ6051AT - MJ6091AT: 5 niveaux de puissance - commandes manuelles.  
MJ6053AT - MJ6093AT: 50 programmes de cuisson et fonction self-service - programmable - fonction multiplicateur x2 - compteur de cycles de travail pour chaque programme - verrouillage du clavier - fonction avertisseur de nettoyage du filtre.

DE Samsung Mikrowellenöfen. Gehäuse und Garkammer aus Edelstahl - 2 Magnetrons - 26 L Garraum mit festem Boden - Innenbeleuchtung - leicht abnehmbarer Luftfilter - stapelbar.  
MJ6051AT - MJ6091AT: 5 Leistungsstufen - manuelle Steuerung.  
MJ6053AT - MJ6093AT: 50 Garprogramme und Selbstbedienungsfunktion - einstellbar - Multiplikatorfunktion x2 - Arbeitszykluszähler pro Programm - Tastensperre - Filterreinigung Warnfunktion.

ES Hornos microondas Samsung. Estructura y cámara de cocción de acero inoxidable - 2 magnetrones - cámara de cocción de 26 litros con fondo fijado - iluminación interior - filtro de aire (que se extrae y superpone fácilmente).  
MJ6051AT - MJ6091AT: 5 niveles de potencia - mandos manuales.  
MJ6053AT - MJ6093AT: 50 programas de cocción self-service - programable - función de multiplicación x2 - contador de ciclos de trabajo para programa - bloqueo de teclado - alarma que avisa cuando se necesita limpiar el filtro.

RU СВЧ-печи Samsung. Корпус из нержавеющей стали и варочная камера - 2 магнетрона - 26 литров варочной камеры с фиксированным дном - внутреннее освещение - легко съемный воздушный фильтр - штабелируемый.  
MJ6051AT - MJ6091AT: 5 уровней мощности - ручное управление.  
MJ6053AT - MJ6093AT: 50 программ приготовления пищи и функция самообслуживания - программируемая - 2 умножающаяся функция - счетчик рабочих циклов по программе - замок клавиш - функция предупреждения о необходимости очистки фильтра.

	MJ6051AT	MJ6091AT	MJ6053AT	MJ6093AT
	1,5 kW	1,85 kW	1,5 kW	1,85 kW
	230V/1N/50Hz			
	Manuale - Manual - Ручным		Digitale - Digital - Цифровой	
	26 L - 370 x 370 x 190(h) mm			
	464 x 557 x 368(h) mm			
				
	32 Kg			
	34,5 Kg			
	540 x 660 x 460(h) mm			
	0,164 m <sup>3</sup>			

PANE1840  
PANE3240

44 L



PANE1840













**Panasonic**®

ORIGINAL BRAND

Forni microonde  
Panasonic

MICROWAVES OVENS  
FOURS À MICRO-ONDES  
MIKROWELLEN  
HORNOS MICROONDAS  
МИКРОВОЛНОВЫЕ ПЕЧИ

- IT Forni a microonde Panasonic. Struttura esterna in acciaio inox - 4 magnetron - camera di cottura da 44 L in grado di contenere una vaschetta GN1/1 - fondo fisso in vetro ceramicato - illuminazione interna - ripiano intermedio estraibile in vetro ceramicato. Potenza resa 1,8 kW (PANE1840) - 3,20 kW (PANE3240).
- EN Panasonic microwave ovens. External casing in stainless steel - 4 magnetrons - 44 L cooking chamber suitable for a GN1/1 tray - fixed bottom in ceramic glass - internal lighting - removable intermediate shelf in ceramic glass. Power yield 1,8 kW (PANE1840) - 3,20 kW (PANE3240).
- FR Fours à micro-ondes Panasonic. Corps extérieure en acier inox - 4 magnétrons - Chambre de cuisson de 44 L pour bac GN1/1 - fond fixe en verre céramique - éclairage intérieur - tablette intermédiaire amovible en verre céramique. Puissance fournie 1,8 kW (PANE1840) - 3,20 kW (PANE3240).
- DE Panasonic Mikrowellenöfen. Äußere Gehäuse aus Edelstahl - 4 Magnetrons - 44 L Garraum zur Aufnahme einer GN1/1 Kochplatte - fester Boden aus Keramikglas - Innenbeleuchtung - abnehmbarer Zwischenboden aus Keramikglas. Erzielte Leistung 1,8 kW (PANE1840) - 3,20 kW (PANE3240).
- ES Hornos microondas Panasonic. Estructura exterior de acero inoxidable - 4 magnetrones - cámara de cocción de 44 litros donde se puede colocar una bandeja GN1/1 - fondo fijado de vidrio hecho de cerámica - iluminación interior - estante intermedio extraíble de vidrio hecho de cerámica. Rendimiento de potencia 1,8 kW (PANE1840) - 3,20 kW (PANE3240).
- RU Панасонические микроволновые печи. Внешний корпус из нержавеющей стали - 4 магнетрона - 44 л. Камера подходит для противня GN1/1 - фиксированное дно из стеклокерамики - внутреннее освещение - съемная промежуточная полка из стеклокерамики. МОЩНОСТЬ НА ВЫХОДЕ 1,8 kW (PANE1840) - 3,20 kW (PANE3240).

	PANE1840	PANE3240
	3 kW	5 kW
	-	230-400V/3N/50Hz
	230V/1N/50Hz	-
	Digitale - Digital - цифровой 0÷60'	
	44 L 1x GN1/1 - 535 x 330 x 250(h) mm	
	650 x 526 x 471(h) mm	
		
	54 Kg	65 Kg
	65 Kg	73 Kg
	760 x 670 x 680(h) mm	
	0,346 m³	

FY4L  
FY44L  
FY8L  
FY88L



FY8L

# Friggitrici

FRYERS  
FRITEUSES  
FRITEUSEN  
FREIDORAS  
ФРИТЮРНИЦЫ

IT Friggitrici. Modelli da banco. Struttura, vasca e coperchio in acciaio inox - cestelli a rete estraibili in filo cromato - manici cestelli e pomelli coperchi in plastica termoisolante - resistenze inox - termostato di sicurezza con pulsante di ripristino - versioni a due vasche con doppio termostato per utilizzo indipendente - testata e resistenze removibili. Raggiungono i 180°C in circa 18 minuti - tempo di frittura in circa 7 minuti.

FR Friteuses modèles de table. Corps, cuve et couvercle en acier inox - paniers amovibles en fil chromé - poignées et pommeaux des paniers en matériau thermo-isolant - résistance en acier inox - thermostat de sécurité avec bouton de remise à zéro - versions à deux cuves avec double thermostat pour une utilisation indépendante - collecteur et résistances amovibles. Ils atteignent 180°C en environ 18 minutes temps de friture de 7 minutes environ.

ES Freidoras. Modelos de sobremesa. Carcasa, cuba y tapa de acero inoxidable - cestas desmontables de alambre cromado - asas de cestas y tapas de material termoaislante - resistencias de acero inoxidable - termostato de seguridad con pulsador de rearme - versiones de dos cubas con doble termostato de uso independiente - cabezal y resistencias desmontables. Alcanzan los 180°C en unos 18 minutos de fritura en unos 7 minutos.













EN Fryers. Table-top models. Casing, bowl and lid in stainless steel - removable baskets in chrome-plated wire - baskets handles and lids knobs in thermo-insulating material - stainless steel resistances - safety thermostat with reset button - two-bowls versions with double thermostat for independent use - header and removable resistances. They reach 180°C in about 18 minutes frying time about 7 minutes.

DE Friteusen Tischmodelle. Gehäuse, Wanne und Deckel aus Edelstahl - abnehmbare Körbe aus verchromtem Draht - Korbgriffe und Deckelknöpfe aus wärmeisolierendem Material - Heizkörper aus Edelstahl - Sicherheitsthermostat mit Rückstellknopf - Zwei-Wanne-Versionen mit Doppelthermostat für den unabhängigen Gebrauch - Kopfteil und abnehmbare Heizkörper. Sie erreichen 180°C in etwa 18 Minuten Frittierzeit von etwa 7 Minuten.

RU фритюрницы. Настольные модели. Корпус, чаша и крышка из нержавеющей стали - съемные корзины из хромированной проволоки - ручки корзин и крышек из термоизоляционного материала - резисторы из нержавеющей стали - предохранительные термостаты. с кнопкой сброса - версии с двумя барабанами и независимым двойным термостатом - головой и съемными нагревательными элементами. Они достигают 180°C примерно за 18 минут времени обжарки примерно за 7 минут.



FY4L

	FY4L	FY44L	FY8L	FY88L
	2 kW	2 + 2 kW	2,85 kW	2,85 + 2,85 kW
 1 Ph	230V/1N/50-60Hz			
	50+200°C			
	7,6 L	7,6 + 7,6 L	12,6 L	12,6 + 12,6 L
	4,2 L	4,2 + 4,2 L	8 L	8 + 8 L
	200 x 140 x 120(h) mm	200 x 140 x 120(h) mm x2	240 x 185 x 140(h) mm	240 x 185 x 140(h) mm x2
 mm	210 x 375 x 310(h) mm	435 x 375 x 310(h) mm	265 x 410 x 325(h) mm	545 x 410 x 325(h) mm
				
 NET Kg	4,5 Kg	8,5 Kg	6 Kg	11,5 Kg
 GROSS Kg	5 Kg	10 Kg	8,5 Kg	13 Kg
 mm	270 x 440 x 340(h) mm	440 x 500 x 340(h) mm	450x 330 x 360(h) mm	580 x 430 x 360(h) mm
 m <sup>3</sup>	0,039 m <sup>3</sup>	0,073 m <sup>3</sup>	0,051 m <sup>3</sup>	0,088 m <sup>3</sup>





FY44L



FY88L

FYK04  
YKK02A



FYK04







YKK02A

Riscalda Hot Dog

HOT DOG  
PERRITO CALIENTE  
АППАРАТ ДЛЯ  
ПРИГОТОВЛЕНИЯ ХОТ-ДОГОВ

- IT** Macchine per riscaldare wurstel e cuocere panini. Struttura in acciaio inox - campana in vetro con all'interno cestello inox per cottura wurstel a bagnomaria. Il modello YKK02A è dotato di 2 punzoni per riscaldare il pane.
- EN** Machines for heating sausages and cooking hot dog buns. Stainless steel casing - glass bell with internal stainless steel bowl to cook sausages in a water bath. The YKK02A model is equipped with 2 bun heating plots.
- FR** Machine pour le chauffage de saucisses et la cuisson de petits pains. Corps en acier. Corps en acier inox - cylindre en verre avec bac interne en acier inoxydable pour chauffer les saucisses au bain marie. Le modèle YKK02A est équipé de 2 broches pour chauffer le pain.
- DE** Maschine zum Erhitzen von Würstchen und Brötchen. Gehäuse aus Edelstahl - Glaszylinder mit innenliegender Edelstahlwanne fürs Heizen von Würsten im Wasserbad. Das Modell YKK02A ist mit 2Heizstiften zum Erwärmen des Brotes ausgestattet.
- ES** Máquina para calentar salchichas y cocinar pan. Estructura de acero inoxidable - campana de vidrio con cesta interna de acero inoxidable para calentar salchichas en baño maría. El modelo YKK02A está equipado con 2 punzones para calentar el pan.
- RU** Прибор для разогревания и приготовления булочек и сосисок. Корпус из нержавеющей стали - стеклянный колпак, внутри которого помещена корзинка из нержавеющей стали для приготовления сосисок на пару. Модель YKK02A оснащена 2 штыря для разогревания булочек.

	FYK04	YKK02A
	0,35 kW	0,44 kW
 1 Ph	230V/1N/50-60Hz	
	260 x 300 x 370(h) mm	410 x 345 x 315(h) mm
		
 NET Kg	5 Kg	5,7 Kg
 GROSS Kg	6,5 Kg	6,7 Kg
	310 x 360 x 400(h) mm	420 x 410 x 380(h) mm
 m <sup>3</sup>	0,045 m <sup>3</sup>	0,063 m <sup>3</sup>



FY011



FY011

Cuoci Hot Dog

HOT DOG COOKER  
PERRITO CALIENTE  
АППАРАТ ДЛЯ  
ПРИГОТОВЛЕНИЯ ХОТ-ДОГОВ

- IT** Macchina per riscaldare e cuocere würstel - cottura rapida ed uniforme che conferisce ai prodotti il sapore e la colorazione tipica della cottura alla griglia senza che sia necessario rigirarli manualmente - carcassa in acciaio inox - rulli in acciaio inox AISI 304 - doppio termostato per la regolazione della temperatura - 11 rulli di  $\varnothing$  25 mm e lunghezza 467 mm.
- EN** Hot dog and sausage heating and cooking machine - fast and even cooking that confers products the flavour and colour typical of grilling with no need for manual intervention - stainless steel casing - AISI 304 stainless steel rollers - double thermostat for temperature control - 11 rollers  $\varnothing$  25 mm 467 mm long.
- FR** Appareil de chauffage et de cuisson pour different saucisses - cuisson rapide et uniforme qui donne aux produits la saveur et la couleur typiques du grillage sans intervention manuelle - corps en acier inox - rouleaux en acier inox AISI 304 - double thermostat pour le contrôle de la température - 11 rouleaux de  $\varnothing$  25 mm et longueur 467 mm.
- DE** Maschine zum Erwärmen und Garen verschiedener Würstchen - schnelles und gleichmäßiges Garen, um den Produkten den typischen Geschmack und die typische Farbe des Grillens ohne manuelles Eingreifen zu verleihen - Edelstahlgehäuse - Rollen aus Edelstahl AISI 304 - Doppelthermostat zur Temperaturregelung - 11 Rollen mit  $\varnothing$  25 mm und Länge 467 mm.
- ES** Máquina para calentar y cocinar perritos calientes y salchichas - cocción rápida y uniforme que confiere a los productos el sabor y la coloración típica de la cocción en parrilla sin necesidad de dar la vuelta manualmente - carcasa de acero inoxidable - rodillos de acero inoxidable AISI 304 - termostato doble para el control de la temperatura - 11 rodillos de  $\varnothing$  25 mm y longitud 467 mm.
- RU** Прибор для разогревания и приготовления сосисок и колбасок - Быстрое и равномерное обжаривание, благодаря которому продукты принимают типичный вид приготовленных на гриле без необходимости поворачивать их вручную - Корпус из нержавеющей стали - Валки из нержавеющей стали AISI 304 - двойной термостат для регулирования температуры - 11 роликов диаметром 25 мм и длиной 467 мм.

	<b>FY011</b>
	2,2 kW
 1 Ph	230V/1N/50Hz
	$\varnothing$ 25 mm - 467 mm
 mm	560 x 530 x 200(h) mm
	
 NET Kg	12 Kg
 GROSS Kg	12,5 Kg
 mm	600 x 540 x 220(h) mm
 m <sup>3</sup>	0,070 m <sup>3</sup>

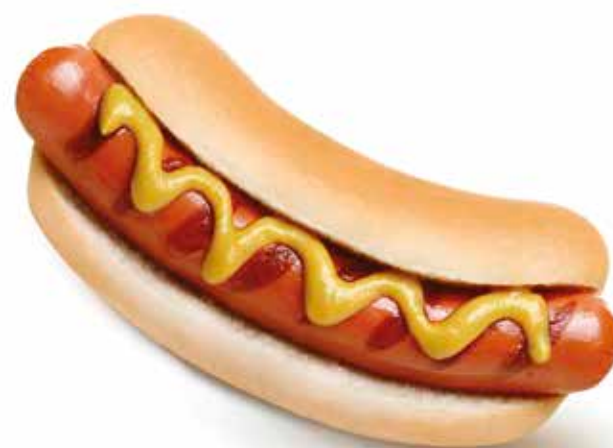

SC8195  
SD82C  
XH215



SC8195



SD82C



XH215

Cuoci riso

RICE COOKER  
CUISINIÈRE À RIZ  
REISKOCHER  
COCEDORES DE ARROZ  
ПІСОВАРКА









IT Macchine cuoci riso. Struttura e interno in acciaio inox - in dotazione cucchiaio e misurino da 180 ml.  
 SC8195: Funzione "Cook" per la cottura del riso - funzione "Warm" per il mantenimento della temperatura. Capacità fino a 30 porzioni di riso.  
 SD82C: Funzione di scelta per la cottura di diversi tipi di riso "Short Grain Rice" o "Long Grain Rice". Possibilità di cuocere zuppe/porridge e di utilizzare il tasto "Delay Timer" fino ad un massimo di 4 ore. Funzione "Warm" per il mantenimento della temperatura. Capacità fino a 45 porzioni di riso.  
 XH215: Funzione "Cook" per la cottura del riso - funzione "Warm" per il mantenimento della temperatura. Capacità fino a 23 porzioni di riso.

EN Rice cookers. Stainless steel casing and interior - supplied with spoon and 180 ml measuring cup.  
 C8195: "Cook" function to cook the rice - "Warm" function to maintain the temperature. Capacity up to 30 portions of rice.  
 SD82C: Selection function to cook different types of rice "Short Grain Rice" or "Long Grain Rice". Can be used to cook soup/porridge and to use the "Delay Timer" button for up to 4 hours. "Warm" function to maintain the temperature. Capacity up to 45 portions of rice.  
 XH215: "Cook" function to cook the rice - "Warm" function to maintain the temperature. Capacity up to 23 portions of rice.

FR Machines pour la cuisson du riz. Corps et intérieur en acier inox - livré avec cuillère et cuillère doseuse de 180 ml.  
 SC8195: Fonction "Cook" pour la cuisson du riz - Fonction "Warm" pour le maintien en température. Capacité jusqu'à 30 portions de riz.  
 SD82C: Fonction de sélection pour la cuisson de différents types de riz "Short Grain Rice" ou "Long Grain Rice". On peut cuire soupe/porridge et la touche "Delay Timer" peut être utilisée jusqu'à 4 heures. Fonction "Warm" pour le maintien en température. Capacité jusqu'à 45 portions de riz.  
 XH215: Fonction "Cook" pour la cuisson du riz - Fonction "Warm" pour le maintien en température. Capacité jusqu'à 23 portions de riz.

DE Reiskocher. Gehäuse und Innenbehälter aus Edelstahl - geliefert mit Löffel und 180 ml Messlöffel.  
 SC8195: "Cook"-Funktion fürs Reiskochen - "Warm"-Funktion fürs Halten der Temperatur. Bis zu 30 Portionen Reis Kapazität.  
 SD82C: Auswahlfunktion für die Zubereitung verschiedener Reissorten "Short Grain Rice" oder Long Grain Rice". Es können Suppe/Brei gekocht werden und die Taste "Delay Timer" kann bis zu 4 Stunden lang verwendet werden. "Warm"-Funktion fürs Halten der Temperatur. Kapazität bis zu 45 Portionen Reis.  
 XH215: "Cook"-Funktion fürs Reiskochen - "Warm"-Funktion fürs Halten der Temperatur. Bis zu 23 Portionen Reis Kapazität.

ES Máquinas de cocción de arroz. Estructura e interior de acero inoxidable - provisto con cuchara y cuchara dosificadora de 180 ml.  
 SC8195: Función "Cook" para cocinar arroz - Función "Warm" para mantener la temperatura. Capacidad hasta 30 porciones de arroz.  
 SD82C: Función de selección para cocinar diferentes tipos de arroz "Arroz de grano corto" o "Arroz de grano largo". Se puede cocinar sopa/pastilla y el botón "Delay Timer" se puede utilizar hasta 4 horas. Función "Warm" para mantener la temperatura. Capacidad hasta 45 porciones de arroz.  
 XH215: Función "Cook" para cocinar arroz - Función "Warm" para mantener la temperatura. Capacidad hasta 23 porciones de arroz.

	SD82C	SC8195	XH215
	2,5 kW	1,95 kW	1,55 kW
 1 Ph	230V/1N/50-60Hz		
	8,2 L (riso crudo - raw rice - сырой рис)	5,4 L (riso crudo - raw rice - сырой рис)	4,2 L (riso crudo - raw rice - сырой рис)
	540 x 460 x 410/880(h) mm	480 x 390 x 350/770(h) mm	470 x 390 x 310(h) mm
			
	14 Kg	9 Kg	5 Kg
	16,5 Kg	10,5 Kg	6 Kg
	550 x 460 x 550(h) mm	460 x 380 x 460(h) mm	400 x 400 x 280(h) mm
	0,136 m <sup>3</sup>	0,078 m <sup>3</sup>	0,045 m <sup>3</sup>

RU Рисовые плиты. Внутренняя и внутренняя отделка из нержавеющей стали - поставляется с ложкой и 180 мл мерной чашкой.  
 SC81195: функция "Готовить" для приготовления риса - функция "Тепло" для поддержания температуры. Вместимость до 30 порций риса.  
 SD82C: Функция выбора для приготовления риса различных сортов "Короткозерновой рис" или "Длиннозернистый рис". Используется для приготовления супа/каши и для использования кнопки "Delay Timer" до 4 часов. Функция "Тепло" для поддержания температуры. Вместимость до 45 порций риса.  
 XH215: функция "Готовить" для приготовления риса - функция "Тепло" для поддержания температуры. Вместимость до 23 порций риса.

FZ03A  
SV130



FZ03A













SV130

Cottura sous-vide

SOUS-VIDE COOKING  
CUISSON SOUS-VIDE  
VAKUUM GAREN  
COCCIÓN SOUS-VIDE  
ВАКУУМНАЯ ВАРКА

- IT** Macchine per la cottura sottovuoto a bassa temperatura (sous-vide). Struttura in acciaio inox AISI 304 - capacità di scaldare fino a 30 L di acqua - sensore di temperatura - temperatura regolabile da 5 a 90° - precisione di lavorazione +/- 0,1°C (mod. SV130) +/- 0,5°C (per il modello FZ03A) - timer da 5 minuti a 99 ore (per il modello SV130) - timer da 5 minuti a 24 ore (per il modello FZ03A).
- EN** Low temperature vacuum cooking machine (sous-vide). Casing in stainless steel AISI 304 - water heating capacity of up to 30 L - temperature probe - temperature adjustable from 5 to 90° - working accuracy +/- 0,1°C (mod. SV130) +/- 0,5°C (mod. FZ03A) - timer from 5 minutes to 99 hours (mod. SV130) - timer from 5 minutes to 24 hours (mod. FZ03A).
- FR** Machine de cuisson sous vide à basse température (sous-vide). Corps en acier Inox AISI 304 - capacité de chauffage de l'eau jusqu'à 30 L - sonde de température - température réglable de 5 à 90° - précision d'usinage +/- 0,1°C (mod. SV130) - +/- 0,5°C (mod. FZ03A) - minuterie de 5 minutes à 99 heures (mod. SV130) - minuterie de 5 minutes à 24 heures (mod. FZ03A).
- DE** Niedertemperaturgargerät für das Vakuumkochen (sous-vide). Gehäuse aus Edelstahl AISI 304 - Wasserheizleistung bis zu 30 L - Temperaturfühler - C - Temperatur einstellbar von 5 bis 90° Bearbeitungsgenauigkeit +/- 0,1°C (SV130) +/- 0,5°C (FZ03A) - Zeitschaltuhr von 5 Minuten bis 99 Stunden (SV130) - Zeitschaltuhr von 5 Minuten bis 24 Stunden (FZ03A).
- ES** Máquina de cocción al vacío de baja temperatura (sous-vide). Cuerpo en acero inoxidable AISI 304 - capacidad de calentamiento de agua de hasta 30 L - sensor de temperatura - temperatura ajustable de 5 a 90° - precisión de tratamiento +/- 0,1°C (mod. SV130) +/- 0,5°C (mod. FZ03A) - temporizador de 5 minutos a 99 horas (Mod.SV130) - temporizador de 5 minutos a 24 horas (mod.FZ03A).
- RU** Низкотемпературная варочная панель для приготовления в вакууме (су-вид). Корпус из нержавеющей стали AISI 304 - мощность водяного отопления до 30 л - Датчик температуры - температура регулируется от 5 до 90° - Точность обработки +/- 0,1°C (SV130) - Точность обработки +/- 0,5°C (FZ03A) - таймер от 5 минут до 99 часов (SV130) таймер от 5 минут до 24 часов (FZ03A).

	FZ03A	SV130
	1,5 kW (1,1 HP)	
 1 Ph	230V/1N/50-60Hz	
	30 L	20/30 L
 mm	140 x 110 x 332(h) mm	71 x 146 x 340(h) mm
		
 NET Kg	2,5 Kg	1,9 Kg
 GROSS Kg	3 Kg	2,2 Kg
 mm	220 x 190 x 410(h) mm	170 x 110 x 385(h) mm
 m³	0,018 m³	0,00725 m³



GUARDA IL VIDEO  
WATCH THE VIDEO

SBS300P  
SBP350  
SBP400

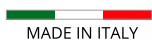

SBP350



SBS300P



SBP400

# Macchine sottovuoto a barra saldante

BAR VACUUM PACKERS  
MACHINES SOUS VIDE À BARRE  
VAKUUMVERPACKER MIT SCHWEISSLEISTE  
ENVASADORAS AL VACÍO CON BARRA  
ВАКУУМНЫЕ УПАКОВОЧНЫЕ МАШИНЫ СО  
СВАРОЧНОЙ ПЛАНКОЙ

**IT** Macchina per prolungare i tempi di conservazione degli alimenti mantenendone intatte le caratteristiche organolettiche. Tramite l'utilizzo di apposite buste goffrate o contenitori si crea un livello di vuoto tale da impedire la proliferazione batterica. Carcassa in acciaio inox (in plastica ABS per il modello SBS300P) - pompa a secco - pannello comandi digitale con ciclo di lavoro automatico e/o manuale - saldatura da 5 mm. Accessori: sacchetti goffrati in vari formati.

**EN** A machine to prolong food storage duration ensuring the integrity of the organoleptic characteristics. The use of special embossed envelopes or containers creates a vacuum level that prevents the proliferation of bacteria. Stainless steel casing (ABS plastic for SBS300P model) - dry pump - digital control panel with automatic and/or manual working cycle - 5 mm sealing. Accessories: embossed bags in various sizes.

**FR** Machine pour prolonger les temps de conservation des aliments tout en conservant intactes les caractéristiques organoleptiques. Grâce à l'utilisation de boîtes gaufrées ou de récipients spéciaux, on obtient un niveau de vide qui empêche la prolifération bactérienne. Corps en acier Inox (en plastique ABS pour le modèle SBS300P) - pompe à sec - panneau de commande numérique avec cycle de travail automatique et/ou manuel - soudure 5 mm. Accessoires: boîtes gaufrés de différents formats.

**DE** Maschine zur Verlängerung der Aufbewahrungsdauer von Lebensmitteln, um die Integrität der organoleptischen Eigenschaften zu gewährleisten. Durch den Einsatz von geprägte Beutel oder Behälter wird ein Vakuumniveau erzeugt, dass die Keimvermehrung verhindert. Edelstahlgehäuse (aus ABS-Kunststoff für das Modell SBS300P) - Trockenlaufpumpe - digitales Bedienfeld mit automatischem und/oder manuellem Arbeitszyklus - 5 mm Siegelung. Zubehör: geprägte Beutel in verschiedenen Formaten.

**ES** Máquina para prolongar el tiempo de conservación de los alimentos manteniendo sus características organolépticas. A través del uso de bolsas o contenedores especiales crea un nivel de vacío tal que impida la proliferación de bacterias. Carcasa de acero inoxidable (de plástico ABS en el modelo SBS300P) - bomba seca bara - panel de control digital con ciclos de trabajos manuales y/o automáticos - sellado de 5 mm. Accesorios: bolsas gofradas de diferentes tamaños.

**RU** Машина для продления срока хранения продуктов. обеспечение целостности органолептических характеристик. Использование специальных тисненых конвертов или контейнеров создает уровень вакуума, предотвращающий размножение бактерий. Корпус из нержавеющей стали (ABS пластик для модели SBS300P) - сухой насос - цифровая панель управления с автоматическим и/или ручным циклом работы - 5 мм уплотнение. Аксессуары: тисненные пакеты различных размеров.

Utilizzare solo buste per sottovuoto goffrate.













Use only embossed bags.

Utiliser seulement les sachets gaufrés.

Nur gaufrierte Beutel fuer vakuum benutzen.

Usar solo bolsas para envasado al vacío gofradas.

Использовать только пакеты для вакуума с тиснением.

	SBS300P	SBP350	SBP400
	0,19 kW (0,25 HP)	0,25 kW (0,33 HP)	0,27 kW (0,36 HP)
	230V/1N/50Hz		
	300 mm	350 mm	400 mm
	0,6 m³/h	1,2 m³/h	
	80%		
	380 x 180 x 80(h) mm	370 x 260 x 130(h) mm	420 x 260 x 130(h) mm
			
	2 Kg	7,5 Kg	8 Kg
	2,5 Kg	8,2 Kg	9 Kg
	440 x 260 x 120(h) mm	420 x 290 x 210(h) mm	510 x 330 x 240(h) mm
	0,014 m³	0,026 m³	0,040 m³

#### Special Voltages - Разное питающее напряжение

Mod. SBP350 - SBP400

SCC250  
SCC300  
SCC400  
SCC500



SCC300

MADE IN ITALY

# Macchine sottovuoto a campana

CHAMBER VACUUM PACKERS  
MACHINES SOUS VIDE À CLOCHE  
KAMMER VAKUUMVERPACKER  
ENVASADORAS AL VACÍO  
КОЛПАКОВЫЕ ВАКУУМНЫЕ УПАКОВОЧНЫЕ  
МАШИНЫ АВТОМАТИЧЕСКИ

**IT** Macchina per prolungare i tempi di conservazione degli alimenti mantenendone intatte le caratteristiche organolettiche e impedendo la proliferazione batterica. Struttura e vasca stampata in acciaio inox - barra saldante estraibile - coperchio in plexiglass trasparente - pompa a bagno d'olio - pannello comandi digitale con 6 programmi memorizzabili - possibile predisposizione per l'utilizzo di gas inerti (escluso mod. SCC250).  
Accessori: sacchetti lisci normali e per cottura in vari formati.

**EN** A machine to prolong food storage duration ensuring the integrity of the organoleptic characteristics and preventing bacterial growth. Stainless steel case and bowl - removable sealing bar - clear plexiglass lid - oil bath pump - digital control panel with 6 storable programs - prearrangement for the use of inert gases (excluding mod. SCC250).  
Accessories: normal smooth bags and cooking bags in various sizes.













**FR** Machine pour prolonger la durée de conservation des aliments, en conservant intacts leurs caractéristiques organoleptiques et en empêchant la prolifération des bactéries. Corps et cuve moulé en acier Inox - barre de soudure amovible - couvercle en plexiglas transparent - pompe à bain d'huile - panneau de commande numérique avec 6 programmes mémorisables - éventuelle prédisposition pour l'utilisation des gaz inertes (sauf le modèle SCC250).  
Accessoires: boîtes lisses normaux et sacs de cuisson de différentes tailles.

**DE** Maschine zur Verlängerung der Aufbewahrungsdauer von Lebensmitteln, um die Integrität der organoleptischen Eigenschaften zu gewährleisten und das Bakterienwachstum zu verhindern. Gehäuse und Schüssel aus Edelstahl - abnehmbare Schweißleiste - klarer Plexiglasdeckel - Ölbadpumpe - digitales Bedienfeld mit 6 speicherbaren Programmen - Inertgasen-Einsatzbereit (Außer Mod. SCC250).  
Zubehör: übliche Glattbeutel und Kochbeutel in verschiedenen Größen.

**ES** Máquina para prolongar el tiempo de conservación de los alimentos manteniendo sus características organolépticas. A través del uso de bolsas o contenedores especiales crea un nivel de vacío tal que impida la proliferación de bacterias. Estructura y cuba impresa de acero inoxidable - barra de termosellado extraíble - tapa en plexiglás transparente - bomba en aceite - panel de control digital con 6 programas memorizables - posible predisposición para el uso de gases inerte (mod. SCC250 excluido).  
Accesorios: bolsas lisas normales y para la cocción, de diferentes tamaños.

**RU** Машина для продления срока хранения продуктов. обеспечение целостности органолептических свойств и предотвращение роста бактерий. Корпус и чаша из нержавеющей стали - съемная уплотнительная планка - прозрачная плексигласовая крышка - масляные насосы - цифровая панель управления с 6 сохраняемыми программами - предварительное согласование для использования инертных газов (кроме модели SCC250).  
Аксессуары: обычные гладкие пакеты и варочные пакеты различных размеров.

Utilizzare solo buste per sottovuoto lisce.  
Use only smooth vakuum bags.  
N'utilisez que des sacs sous vide lisses.  
Nur glatte Vakuumbbeutel benutzen.  
Utilizar exclusivamente bolsas para envasado al vacío lisas.  
Использовать только гладкие пакеты для вакуума.

	SCC250	SCC300	SCC400	SCC500
	0,35 kW (0,46 HP)	0,45 kW (0,6 HP)	0,75 kW (1 HP)	
	230V/1N/50Hz	230V/1N/50-60Hz		
	250 mm	300 mm	400 mm	500 mm
	4 m³/h	8 m³/h	20 m³/h	
	98%			
	260 x 300 x 110(h) mm	310 x 350 x 190(h) mm	410 x 450 x 220(h) mm	520 x 520 x 220(h) mm
	320 x 500 x 270(h) mm	460 x 410 x 430(h) mm	560 x 510 x 460(h) mm	610 x 630 x 500(h) mm
				
	26 Kg	35 Kg	50 Kg	64 Kg
	32 Kg	40 Kg	58 Kg	74Kg
	550 x 470 x 620(h) mm	600 x 800 x 640(h) mm	600 x 800 x 680(h) mm	700 x 700 x 670(h) mm
	0,161 m³	0,307 m³	0,326 m³	0,329 m³

Special Voltages - Разное питающее напряжение

Predisposizione per l'utilizzo di gas inerti  
Prearrangement for the use of inert gases

Mod. SCC300 - SCC400 - SCC500

# Optional

ACCESSORIES  
ACCESSOIRES  
ZUBEHÖR  
ACCESORIOS  
AKCECCYAPЫ

Buste goffrate e lisce - Embossed and smooth bags - Sacs gaufrés et lisses - Geprägte und Glatte Beutel - Bolsas gofrados y lisas - Тисненные и гладкие конверты

	Confezione 100 pz - Pack 100 pcs - 100 pièces par paquet 100 Stk. Packung - 100 uds. por caja - 100 шт. в упаковке	Temp. max / h	 mm
SAC03	<b>µm 90</b> Buste Goffrate - Conservazione e cottura Embossed bags - Preservation and cooking Sacs gaufrés - Conservation et cuisson Geprägte Beutel - Konservieren und kochen Bolsas gofrados - Conservación y cocina Конверты с тиснением - хранение и приготовление	100°C - 2 h	150 x 300 mm
SAC01			200 x 300 mm
SAC19			200 x 400 mm
SAC05			250 x 350 mm
SAC02			300 x 400 mm
SAC18			400 x 600 mm
SAC03C	<b>µm 90</b> Buste Goffrate per cottura extra performance Embossed bags for extra performance cooking Sacs gaufrés pour une cuisson encore plus performante Geprägte Beutel für besonders leistungsstarkes Kochen Bolsas gofradas para una cocción de mayor rendimiento Рельефные пакеты для более эффективного приготовления	120°C - 4 h	150 x 300 mm
SAC01C			200 x 300 mm
SAC02C			300 x 400 mm
SAC18C			400 x 600 mm
SAC27C	<b>µm 90</b> Buste lisce - Conservazione e cottura Smooth bags - Preservation and cooking Sacs lisses - Conservation et cuisson Glatte Beutel - Konservieren und kochen Bolsas lisas - Conservación y cocina Гладкие пакеты - Хранение и приготовление пищи	100°C - 2 h	150 x 300 mm
SAC11			200 x 300 mm
SAC12			250 x 350 mm
SAC14			300 x 400 mm
SAC16			400 x 500 mm

2 rotoli - 2 rolls - 2 rouleaux - 2 Rollen - 2 rollos - 2 рулонов

	 mm
ROT01	200 x 6000 mm
ROT02	300 x 6000 mm

ROT01



ROT02

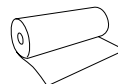



HBS220JS  
HBS250  
HBS300



HBS220JS



HBS250



HBS300

Affettatrici a gravità

GRAVITY SLICERS  
TRANCHEUSE À GRAVITÉ  
SCHRÄGE AUFSCHNITTMASCHINEN  
CORTADORAS POR GRAVEDAD  
ГРАВИТАЦИОННЫЕ СЛАЙСЕРЫ

**IT** Macchina per affettare salumi, formaggi, ecc. Struttura in lega leggera di alluminio anodizzato - anello fisso protezione lama - paralama estraibile - pomello regolazione vela con scala graduata - affilatoio fisso con coppia di smerigli per l'affilatura della lama. Spessore di taglio per il modello 220JS fino a 12 mm, per il modello 250 fino a 15 mm e per il modello 300 fino a 16 mm - blocco piatto-vela.

**EN** Slicing machine for cold cuts, cheeses, etc. Casing in light anodized aluminium alloy - fixed ring for blade protection - removable blade guard - fence adjustment knob with graduated scale - fixed sharpener with a pair of grinders to sharpen the blade. Cutting thickness for the 220JS model up to 12 mm, for the 250 model up to 15 mm and for the 300 model up to 16 mm - plate block.

**FR** Trancheuse pour saucisses et fromages, etc. Corps en alliage d'aluminium anodisé léger - anneau fixe pour la protection de la lame - garde lame extractible - bouton de réglage de la voile avec échelle graduée - affûteur fixe avec couple d'émeris pour aiguiser la lame. Epaisseur de coupe pour modèle 220JS jusqu'à 12 mm, pour modèle 250 jusqu'à 15 mm et pour modèle 300 jusqu'à 16 mm - bloc du plan glissant.

**DE** Schneidemaschine für Wurstwaren, Käse, usw. Gehäuse aus leichter eloxierter Aluminiumlegierung - fester Ring für den Messerschutz - abnehmbarer Messerschutz - Segelstellknopf mit Skala - fester Schärfer mit einem Paar Schleifer zum Schärfen der Klinge. Schnittstärke für das 220JS Modell bis 12 mm, für das 250 Modell bis 15 mm und für das 300 Modell bis 16 mm - Einführtischsperre.

**ES** Máquina para cortar en lonchas embutidos, quesos, etc. Estructura ligera de aleación de aluminio anodizado - anillo fijo para proteger la cuchilla y protección de la cuchilla extraíble - pomo de regulación protección vertical con escala graduada - afilador fijo piedras de amolar para afilar la cuchilla. Espesor del corte hasta 12 mm (modelo 220JS), hasta 15 mm (modelo 250), hasta 16 mm (modelo 300). Bloque plano-protección vertical.

**RU** Режущая машина для нарезки холодной нарезки, сыров и т.д. Корпус из легкого анодированного алюминиевого сплава - фиксированное кольцо для защиты лезвия - съемная защита лезвия - ручка регулировки ограждения с градуированной шкалой - фиксированная точилка с парой шлифмашин для заточки лезвия. Толщина резания для модели 220JS до 12 мм, для модели 250 до 15 мм и для модели 300 до 16 мм - листовой блок.

	HBS220JS	HBS250	HBS300
	0,12 kW	0,15 kW	0,25 kW
 1 Ph	230V/1N/50Hz		
 mm	220 mm	250 mm	300 mm
 mm	115 x 130(h) mm	140 x 155(h) mm	165 x 175(h) mm
 mm	340 x 240 mm	380 x 250 mm	430 x 300 mm
 mm	490 x 370 x 330(h) mm	520 x 420 x 380(h) mm	560 x 490 x 450(h) mm
			
 NET Kg	12 Kg	18 Kg	23 Kg
 GROSS Kg	14 Kg	20 Kg	26 Kg
 mm	520 x 420 x 380(h) mm	580 x 470 x 420(h) mm	620 x 530 x 510(h) mm
 m <sup>3</sup>	0,083 m <sup>3</sup>	0,111 m <sup>3</sup>	0,165 m <sup>3</sup>



HT4  
HT55



HT4









HT55

# Taglia pomodori manuali

TOMATOES CUTTER  
COUPE-TOMATES  
TOMATENSCHNEIDER  
CORTADORA DE TOMATES  
РЕЗКА ПОМИДОРОВ

- IT Macchina per tagliare pomodori. Struttura in acciaio inox e plastica alimentare. Il modello HT4 ha uno spessore di taglio di 4 mm, mentre il modello HT55 ha spessore di 5,5 mm.
- EN Tomato cutting machine. Stainless steel and food safe plastic casing. The HT4 model has a cutting thickness of 4 mm, while the HT55 model has a thickness of 5,5 mm.
- FR Machine à couper les tomates. Corps en acier inox et plastique alimentaire. Le modèle HT4 a une épaisseur de coupe de 4 mm, et le modèle HT55 a une épaisseur de 5,5 mm.
- DE Tomatenschneidemaschine. Gehäuse aus Edelstahl und lebensmittelechtem Kunststoff. Das Modell HT4 hat eine Schnittdicke von 4 mm, während das Modell HT55 eine Dicke von 5,5 mm hat.
- ES Máquina para cortar tomates. Estructura de acero inoxidable y plástico idóneo para el contacto con los alimentos. Espesor del corte: 4 mm (modelo HT4) o 5,5 mm (modelo HT55).
- RU Машина для резки помидоров. Корпус из нержавеющей стали и пищевого безопасного пластика. Модель HT4 имеет толщину пропила 4 мм, а модель HT55 - 5,5 мм.

	HT4	HT55
 LAME BLADES ЛЕЗВИИ	N° 13	N° 10
 mm	450 x 200 x 205(h) mm	
		
 NET Kg	5 Kg	
 GROSS Kg	6 Kg	
 mm	450 x 210 x 210(h) mm	
 m <sup>3</sup>	0,020 m <sup>3</sup>	

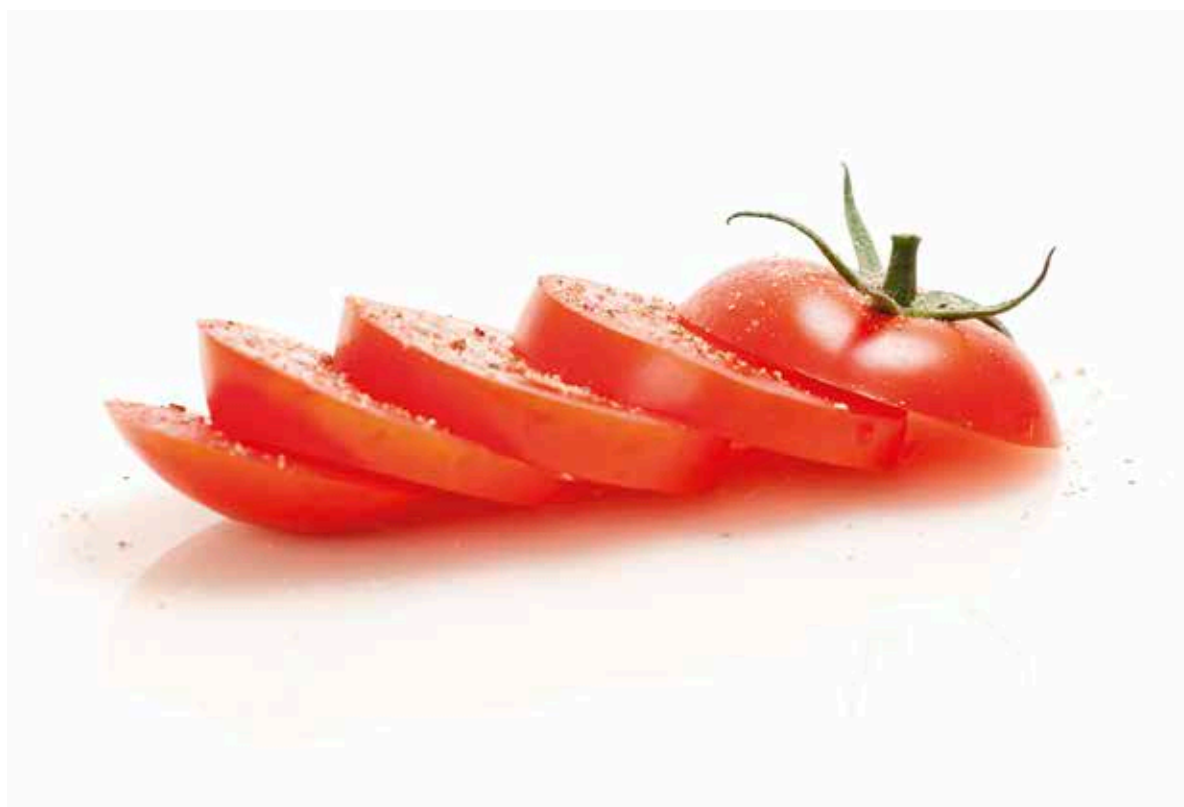

HF100  
HF130



















HF100

# Pressamburger manuali

HAMBURGER PRESS  
PRESSE-HAMBURGER  
HAMBURGERPRESSE  
FORMADORA DE HAMBURGUESAS  
ПРЕСС ДЛЯ ГАМБУРГЕРОВ

- IT Struttura in alluminio anodizzato, parti a contatto con la carne in acciaio inox.
- EN Anodized aluminium casing, parts in contact with the meat in stainless steel.
- FR Corps en aluminium anodisé, parties en contact avec la viande en acier inox.
- DE Gehäuse aus eloxiertem Aluminium, mit dem Fleisch in Kontakt tretenden Teile aus Edelstahl.
- ES Estructura de aluminio anodizado, las partes que están a contacto con la carne son de acero inoxidable.
- RU Корпус из анодированного алюминия, детали, контактирующие с мясом, изготовлены из нержавеющей стали.

	HF100	HF130
		
	ø 100 mm	ø 130 mm
	320 x 250 x 300(h) mm	
		
	5,2 Kg	
	6,5 Kg	6,7 Kg
	275 x 220 x 295(h) mm	
	0,018 m <sup>3</sup>	

	ACCARTAF10	ACCARTAHF130
		
	ø 100 mm	ø 130 mm
	Confezione cellophan da 1 Kg - 1 Kg cellophane package Emballage cellophane de 1 Kg - Zellophan-Verpackung 1 Kg Caja celofán de 1 Kg - Упаковка целлофана 1 кг	
		
	5,2 Kg	
	6,5 Kg	6,7 Kg
	275 x 220 x 295(h) mm	
	0,018 m <sup>3</sup>	



T906













T906

# Bollitore elettrico

ELECTRIC KETTLE  
BOUILLLOIRE ÉLECTRIQUE  
WASSERKOCHER  
HERVIDOR ELÉCTRICO  
ЭЛЕКТРИЧЕСКИЙ ЧАЙНИК

- IT Bollitore elettrico in acciaio inox - spegnimento automatico al raggiungimento dell'ebollizione - due livelli di potenza - capacità contenitore 1,7 L - livello acqua visibile - base in plastica.
- EN Stainless steel electric kettle - automatically switches off when boiling temperature is reached - two power levels - 1.7 L container - visible water level - plastic base.
- FR Bouilloire électrique en acier inox. Arrêt automatique une fois la température d'ébullition atteinte - deux niveaux de puissance - capacité du récipient 1,7 L - niveau d'eau visible - base en plastique.
- DE Elektrischer Wasserkocher aus Edelstahl - automatische Abschaltung beim Kochen - zwei Leistungsstufen - 1,7 L Behälterinhalt. - sichtbarer Wasserstand - Kunststoffsockel.
- ES Hervidor eléctrico de acero inoxidable - cierre automático cuando el agua hierve - dos niveles de potencia - capacidad 1,7 litros - nivel de agua visible - base de plástico.
- RU Электрочайник из нержавеющей стали - автоматически выключается при достижении температуры кипения - два уровня мощности - 1,7 литровый контейнер - видимый уровень воды - пластиковое основание.

	<b>T906</b>
	1,85 - 2,2 kW
 1 Ph	230V/1N/50-60Hz
	1,7 L
	150 x 220 x 230(h) mm
	
 NET Kg	1,3 Kg
 GROSS Kg	1,5 Kg
 mm	220 x 180 x 250(h) mm
 m <sup>3</sup>	0,010 m <sup>3</sup>







**Fimar S.p.a.**

Via Del Tesoro, 301

47826 Villa Verucchio (Rimini) Italy

t. +39 0541 670736

info@fimargroup.it

**FIMARGROUP.IT**  
**FIMARSPA.IT**  
**EASYLINEBYFIMAR.IT**  
**FORCAR.IT**  
**FORCOLD.IT**